

water in motion

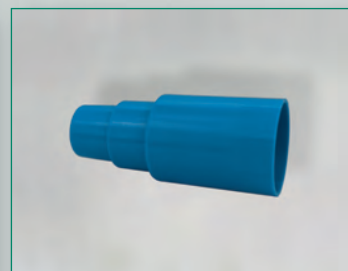

5 Ball valves + heating valves



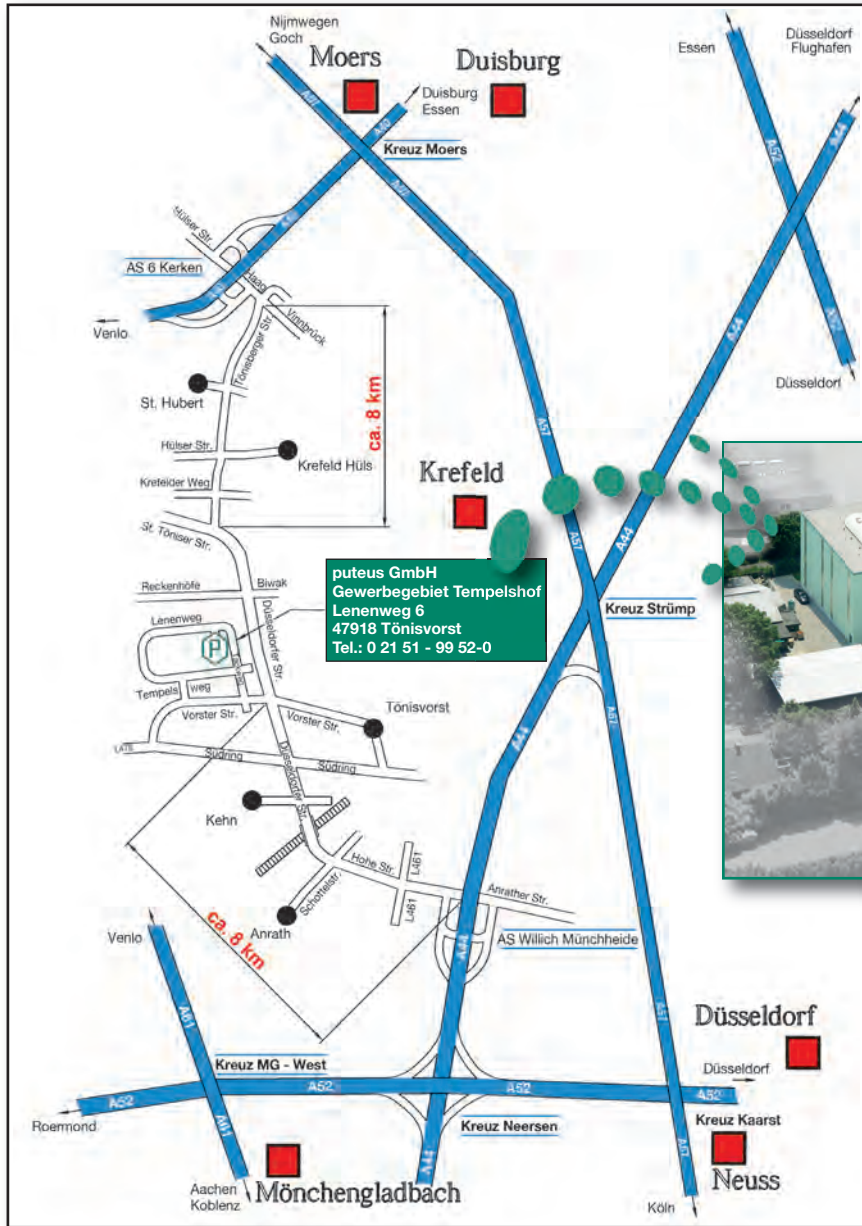

How to find us?

How to reach us?

Phone: +49-(0) 2151-9952-0 • Fax: +49-(0)2151-9952-99 • e-mail: info@puteus.de



Distance Tönisvorst – airport

-  Düsseldorf 34 km
-  Weeze 66 km
-  Köln/Bonn 71 km
-  Dortmund 91 km

Contact:

Prefix:
+49(0)2151...

Phone

Fax

E-Mail

Management

Hans de Gruyter
Purchasing/Finance

9952-22

9952-25

h-degruyter@puteus.de

Peter de Gruyter
Distribution

9952-42

9952-45

p-degruyter@puteus.de

Management Assistance

9952-42

9952-45

b-brender@puteus.de

Sales Manager

9952-50

9952-55

verkauf@puteus.de

Sales Department, Germany

9952-52

9952-55

verkauf@puteus.de

Sales Department, Export

9952-60

9952-55

export@puteus.de

Customer Service and order processing

9952-12

9952-15

vertrieb@puteus.de

Accounting Department

9952-22

9952-24

finanzen@puteus.de

Import/Export customs clearance

9952-23

9952-24

finanzen@puteus.de

Puteus GmbH, a manufacturing and distributing company, was founded in 1979 by the parents of the present share holders. Puteus experienced a rapid development - from a supplier for products of the gardening and irrigation sector to a large range of the heating, plumbing- and garden components.



The company is based in Tönisvorst



The high-bay warehouse

Our modern warehouse with a capacity of 10.000 pallets and a picking area for further 3.000 pallets allows short delivery times.

In addition to our standard product range we also design and manufacture lots of OEM products for the sanitary and heating industries in production sites spread all over the world. Many of our products meet the different requirements and regulations, e.g. DVGW, PA-certificates, KIWA, ACS or SVGW.



Whether the customer orders full pallet units ...



...we supply individually and promptly.

Qualified employees in all areas of the company use their skills to satisfy your individual needs – from the standard fitting to the construction of customer-specific items.

In our German production sites we own different production lines, electroplating and modern robot plants, tool- and mould making as well as turnery and metal-work departments.



...or wishes smaller packing units ...

The owner-managed family company **puteus GmbH** was the starting point for a group of companies of, today, about 250 employees. It has set itself the target of combining optimal quality and service and -at the same time- responding flexibly and promptly to the changes in the market. We are distinguished both by continuous development of knowledge and quality improvements of our products that are in the interest of our customers as well as commitment and curiosity for what is new and feasible.



Ready for shipment.

These following companies also belong to the de Gruyter-Stach-Group



► Schlösser Armaturen GmbH & Co. KG

Im Dohm 3 | D-57462 Olpe
 Phone: +49-27 61-607-0 | Fax: +49-27 61-607-10
 E-Mail: info@schloesser-armaturen.de

Commercial register entry:
 AG Siegen | HRA 8076 | UST-IDNR DE 814 779 086 | Sitz Olpe
 CEO: Henning de Gruyter | Olaf Stach

**Water and heating connection valves
 bib taps · appliance connection fittings
 heating fittings · water meters
 state-certified calibration unit for water meters**



► Heinrich Schulte GmbH & Co. KG

Grünlandweg 11 | D-58640 Iserlohn
 Phone: +49-23 71-90 90-0 | Fax: +49-23 71-90 90-99
 E-Mail: info@heinrichschulte.com

Commercial register entry:
 AG Iserlohn | HRA 2276
 UST-IDNR DE 233 202 839 | Sitz Iserlohn
 CEO: Henning de Gruyter | Olaf Stach

Exclusive sanitary taps and mixers



► Heinrich Schulte GmbH & Co. KG

Giesestrasse 30 | D-58636 Iserlohn
 Phone: +49-23 71-90 90-0 | Fax: +49-23 71-90 90-99
 E-Mail: info@heinrichschulte.com

Commercial register entry:
 AG Iserlohn | HRA 2276
 UST-IDNR DE 233 202 839 | Sitz Iserlohn
 CEO: Henning de Gruyter | Olaf Stach

Exclusive sanitary taps and mixers



5

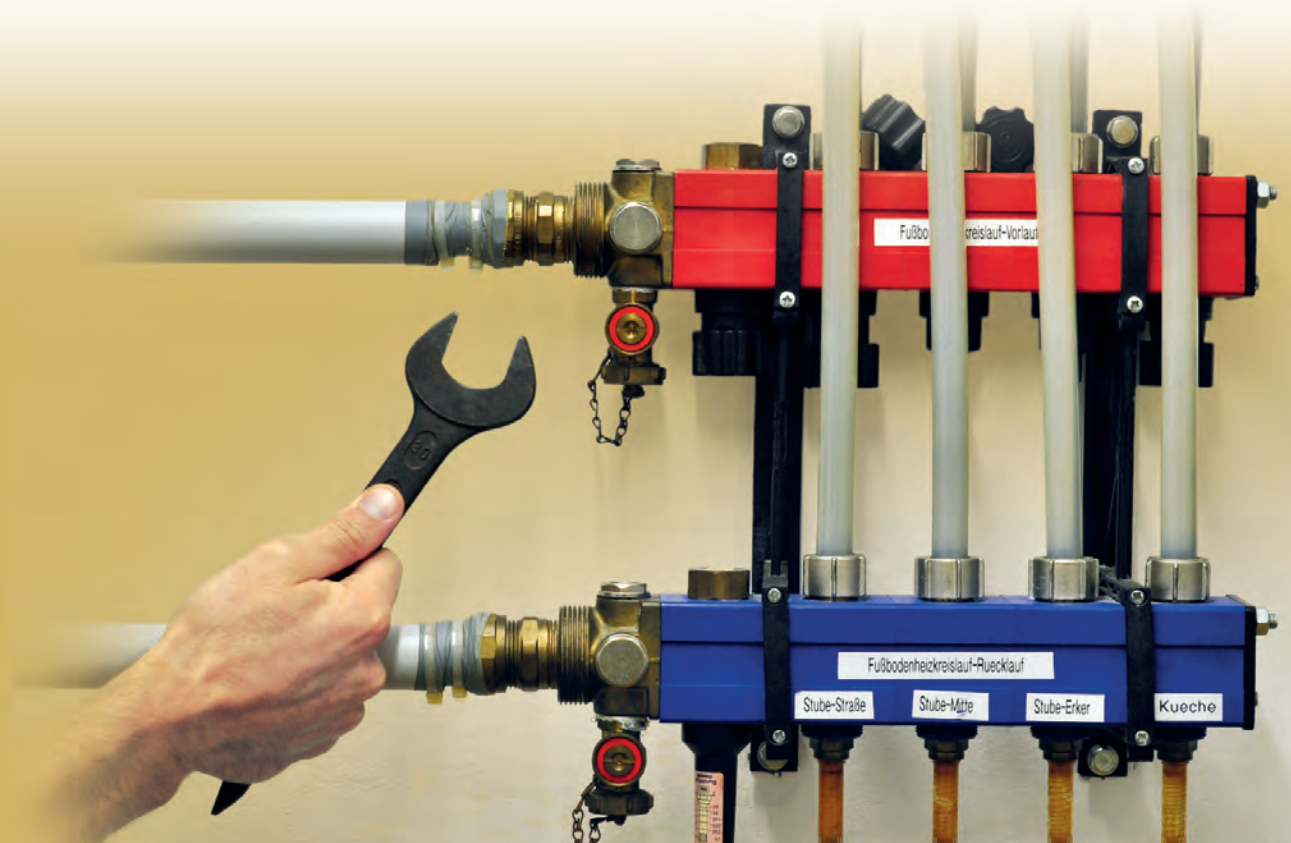

Table of contents

Quarter turn bittaps + multi-port ball valves

Page 6



Brass ball valves

Page 11

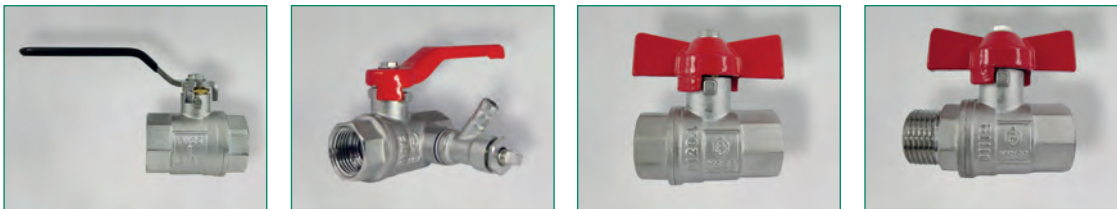

3-way-ball valves + air gates ball valves + lever + handle

Page 17

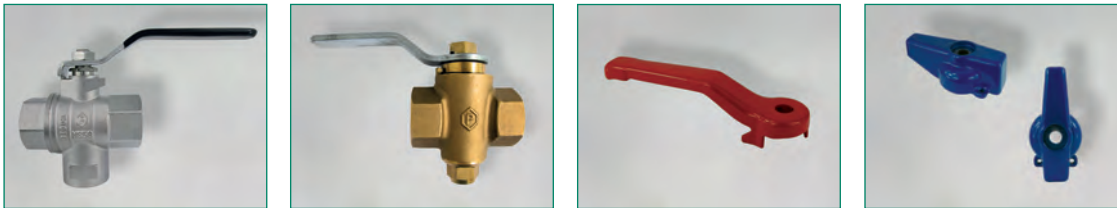

Mini-ball valves + ISO-pump valves + flanged valves

Page 42



Pump ball valves of forged brass

Page 46



Fill and drain valves of forged brass

Page 49



Table of contents

Mounting kits for manifolds + heat meter mounting kits Page 54



Radiator fittings + radiator valves + accessories Page 59



Pump fittings + braided hoses + construction plugs Page 74



Gate valves + socket strainers + angle seat valves Page 81



Valves full flow + check valves for pumps Page 87



Check valves + foot valves + filters Page 91



Brass quarter turn tap (market model)

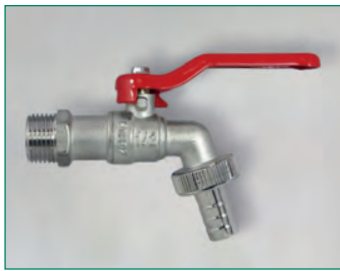

With spacer and hose tail, optionally made of plastic or metal sheet, red lacquer steel lever, material: brass 58 hot-pressed, nickel plated

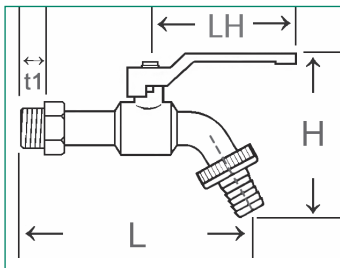

Item-No.:	Item-No.:	Item-No.:	Connection:	Thread length	Length:			Pack. unit:
					t1	L	H	
53071 5	53071-Blau	53071-F	1/2"	13	112	54	77	6/ 90
53072 2	53072-Blau	53072-F	3/4"	13	120	58	77	5/ 75
53073 9		53073-F	1"	15	141	70	85	4/ 32
53077 7		53077-F	3/4" x 1/2" x 3/4"	13				6/120
53078 4		53078-F	3/4" x 3/4" x 1/2"	13			98	5/ 75

Brass quarter turn tap (market model)



Nickel plated, with plastic hose tail, red lacquer steel lever

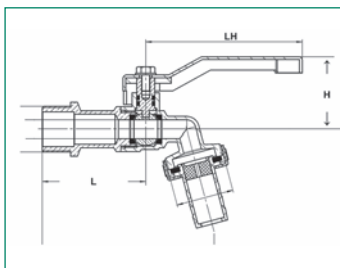

Item-No.:	Connection:	Thread length	Length:			Packing unit:
			t1	L	H	
53275 7	1/2"	-	45,5	31,7	75,5	10/100
53277 1	3/4"	-	45,5	33,1	75,5	-/-

Brass quarter turn tap (market model)



Nickel plated, with plastic hose tail, red lacquer aluminum T-handle

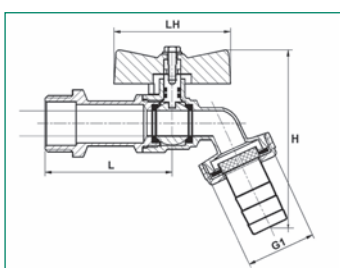

Item-No.:	Connection:	Thread length	Length:			Pack. unit:
			t1	L	H	
53276 4	1/2"	-	75	77,5	44	12/120

Brass quarter turn tap (heavy version)

With spacer and metal sheet hose tail, aluminium lever with fixation (can be remounted, lockable), either red or blue, brass 58 hot-pressed, nickel plated

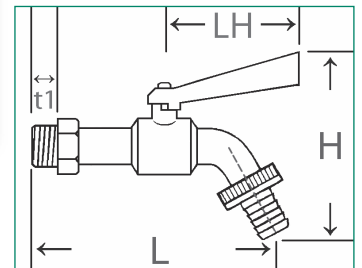

Item-No.:	Item-No.:	Connection:	Thread length	Length:			Packing unit:
				L	H	LH	
Lever blue	Lever red		t1	L	H	LH	
53271 9	53271-R	1/2"	12	102	103	56	4/64
53272 6	53272-R	3/4"	12,5	121	104,5	56	6/48
Replacement handles heavy version:							
53271-Griff	53271-R-Griff	1/2" + 3/4"				56	-/-

Brass drain valve, 90°

Forged brass, chrome plated, with straight spout, red lacquer steel lever

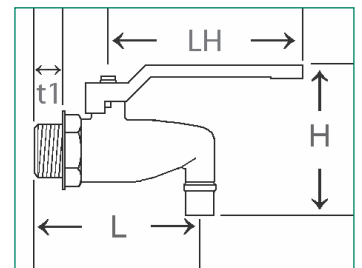

Item-No.:	Connect.:	Thread length:	Length:			Packing unit:
			L	H	LH	
		t1	L	H	LH	
53075 3	1/2"	11	65,5	59	77	5/60

Brass quarter turn tap

With 2 lockable outlets, spacer, separately lockable, with metal sheet hose tail (see illu.) or plug-in connection system, steel lever with red plastic coating

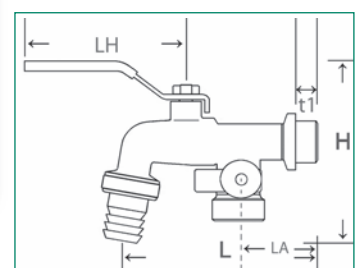

Item-No.:	Conn.:	Conn.:	Thread length:	Length:				Pack. unit:
				L	H	LH	Leaving	
with hose tail	Entrance	Leaving	t1	L	H	LH	LA	
53076 0	1/2"	3/4"		99,2	100	82	41	4/32
53079 1	3/4"	1"		110		82	41	-/-
with plug-in connection								
53076-S	1/2"	3/4"		99,2	100	82	41	4/32
53079-S	3/4"	1"		110		82	41	-/-

Brass drain valve, lockable



Lockable, nickel-plated, with plastic hose screw connection, red painted steel lever, without lock

Item-No.:	Conne.:	Thread length: t1	Length:			Packing unit:
			L	H	LH	
53273 3	1/2"		52	34		6/90
53274 0	3/4"		61,5	34		5/75

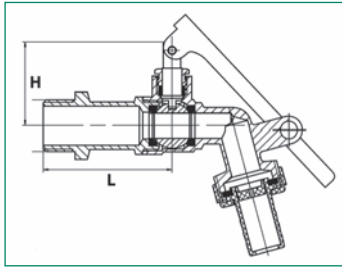

Brass drain valve, lockable



Lockable, nickel-plated, with brass padlock, 2 keys, blue aluminium handle

Item-No.:	Conne.:	Thread length: t1	Length:			Packing unit:
			L	H	LH	
53081 4	1/2"		57,5	51,3	55,5	1/64
53082 1	3/4"		64,5	52,3	55,5	1/48

Spare part padlock, brass body, steel lock shackle chrome-plated, 2 keys

53081-02	35 x 27 x 9,5 x 5,5 mm					
----------	------------------------	--	--	--	--	--

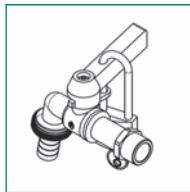
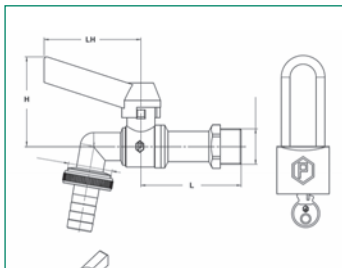

Brass quarter turn tap



Heavy version, self sealing, O-ring EPDM, hose tail made of sheet, steel lever in blue, wrench size 30

Item-No.:	Conne.:	Thread length: t1	Length:			Packing unit:
			L	H	LH	
53278-SD	3/4"	13	103	85	77	8/64

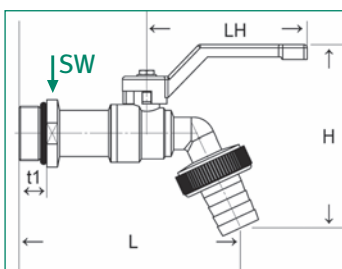

Stainless steel quarter turn tab

Water-carrying components AISI316 = 1.4401, stainless steel lever AISI304 = 1.4301 with blue plastic coating, lockable

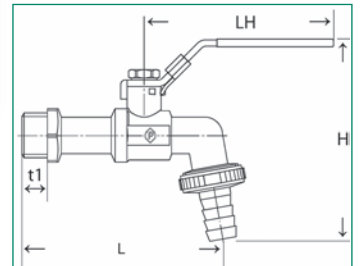

Item-No.:	Conne.:	Thread length:	Length:			Packing unit:
			L	H	LH	
93071 3	1/2"	13	88	87	92	6/120
93072 0	3/4"	11	105	87	92	6/120
93073 7	1"	14	115	120	115	-/-

Lever red, with brass nut, hose tail stainless steel, PN 20

Polyamid drain valve

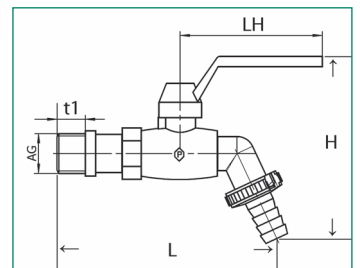

Item-No.:	Conne.:	Thread length:	Length:			Packing unit:
			L	H	LH	
53971-F	1/2"	15	116	97	75	6/72
53972-F	3/4"	15	116	97	75	6/90

Lever blue, male thread made of brass, plug-in coupling made of plastic

Polyamid ball valve

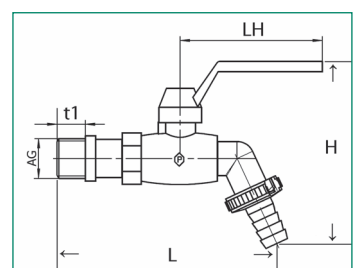

Item-No.:	Conne.:	Thread-length:	Length:	Height:	Length handle:	Packing unit:
53975 6	1/2"	15	110	92	80	6/72

Multi-port ball valve, two-way valve

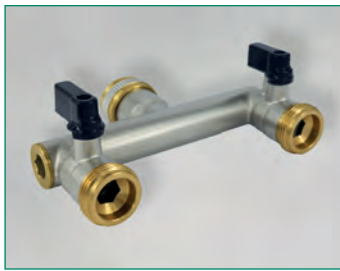

Brass nickel plated, straight, F/M, 2 x ball valve, separately lockable

Item-No.:	Conneс.::	Passage:	Length:		Packing unit:
			L	H	
53304 4	3/4"	10 mm	110	89,5	6/36
53308 2	1"	14,5 mm	110	89,7	4/24

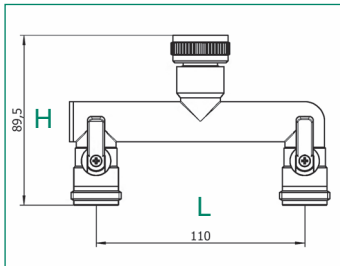

Multi-port ball valve, three-way valve



Brass nickel plated, straight, F/M, 3 x ball valve, separately lockable

Item-No.:	Conneс.::	Passage:	Length:		Packing unit:
			L	H	
53305 1	3/4"	10 mm	110	89,5	3/18
53309 9	1"	14,5 mm	110	89,7	2/12

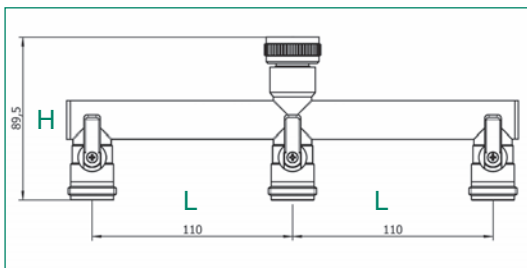

Brass valve for oily substances



Plain brass, lever sheet of metal

Item-No.:	Conneс.::	Departure:	Length:		Packing unit:
			L	H	
S-3315	G 3/4"	∅ 13 mm	70,4		6/72

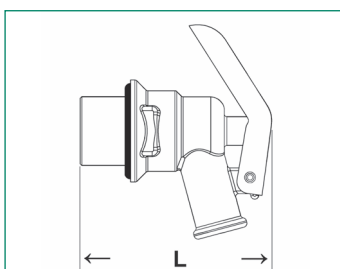

Full flow brass ball valves, nickel plated, ball: brass, hard chrome plated; ball seal made of PTFE: with red or blue painted steel or aluminium lever handle; brass spindle, spindle seal made of FKM, for temperatures of -20°C up to + 150°C, pressure stage for the series PN 25, material: brass according to DIN DVGW 50930-6 (CW 617 N), hot-pressed, cylindrical threads in according to ISO 228-2

(Valid for all ball valves, unless otherwise stated)



Various of our ball valves have been tested by the **Fraunhofer Institute for Building Physics** for their sound class and have received a testimony of their noise behavior according to DIN EN ISO 3822 (test report P-BA 18572016).

These are marked separately (**GKP = noise class test**)

Attestation de Conformité Sanitaire (ACS)



Several of our ball valves have been tested by the French institute "**Institute Eurofins - expertises environnementales**" to demonstrate their conformity with the requirements of the French market and that the material is allowed for the use in contact with drinking water. These ball valves have been certified according to the standard XP P41-280.

Item-No.: Lever steel red	Item-No.: Lever steel blue	Item-No.: Lever aluminium red	Con.:	Ball- pas- sage:	Thread length:		Length:				Packing unit:
					t1	t2	L	Ø	H	LH	
53089 0	-	53010 4	1/4"	10	9,5	9,5	40	23,5	36	77	12/120
53090 6	53090-Blau	53000 5	3/8"	10	9,5	9,5	40	23,5	36	77	12/120
53091 3	53091-Blau	53001 2	1/2"	14,5	12,5	12,5	50	29	41	97	10/ 80
53092 0	53092-Blau	53002 9	3/4"	19	12,5	12,5	55,5	36	49	97	10/ 60
53093 7	53093-Blau	53003 6	1"	24	13	13	63	42,5	52	117	6/ 36
53094 4	53094-Blau	53004 3	1 1/4"	31	15,5	15,5	77,5	55	65	140	4/ 24
53095 1	53095-Blau	53005 0	1 1/2"	40	16,5	16,5	90	69	72	140	2/ 16
53096 8	53096-Blau	53006 7	2"	50	19,5	19,5	109	84,5	87	160	2/ 8
53097 5	-	-	2 1/2"	63	22	22	131	103	102	200	2/ 4
53098 2	-	-	3"	75	23	23	145	123	111	200	2/ 4
53099 9	-	-	4"	95	23	23	174	151	129	250	2/ 2

Ball valve (f/f)

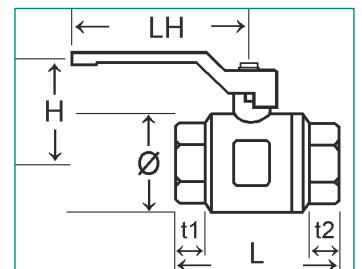

Ball valve (f/f)

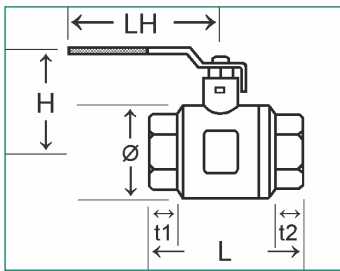

With stainless steel lever, plastic coated, black, with ball and shaft seal (gland) of PTFE

Item-No.:	Con.:	Ball-passage:	Thread length:		Length:				Packing unit:
			t1	t2	L	Ø	H	LH	
53151 4	1/2"	14,5	12,5	12,5	50	29	56	99	10/ 80
53152 1	3/4"	19	12	12	54,5	36	59,5	99	10/ 60
53153 8	1"	24	12,8	12,8	63	42,5	68,5	115	6/ 36
53154 5	1 1/4"	31	15,5	15,5	77,5	55	87,5	125	4/ 24
53155 2	1 1/2"	40	16	16	90	69	94	125	4/ 16
53156 9	2"	50	19,5	19,5	109	84,5	112,2	144	2/ 8



Ball valve (f/f) ACS

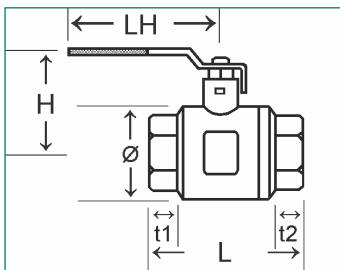
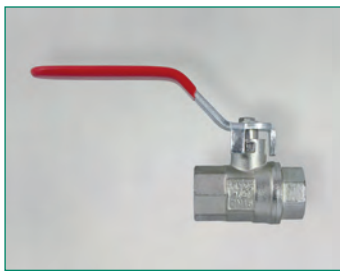

Galvanized steel lever with plastic coated, red, with ball seal of PTFE and shaft seals (O-rings) of EPDM

Item-No.:	Con.:	Ball-passage:	Thread length:		Length:				Packing unit:
			t1	t2	L	Ø	H	LH	
53149-R	1/4"	-	-	-	-	-	-	-	12/120
53150-R	3/8"	9	8	8	38,5	22,5	43,1	83	12/120
53151-R	1/2"	13,5	10	10	47	27	46,9	93	10/ 80
53152-R	3/4"	18	11	11	53	34	50,2	93	10/ 60
53153-R	1"	23	11	11	61	41,5	58,3	116	6/ 36
53154-R	1 1/4"	30	14	14	73	53	73	135	4/ 24
53155-R	1 1/2"	38	15	15	86	65,5	79	135	4/ 16
53156-R	2"	47	17	17	104	78,5	90,5	151,5	2/ 8
53157-R	2 1/2"	63	22	22	132	103	119,5	242,5	2/ 4
53158-R	3"	75	22	22	145	123	128	242,5	2/ 4
53159-R	4"	95	28,5	28,5	180	153	139,6	242,5	1/ 2



F x M, nickel plated, with stuffing box, stainless steel handle with black plastic cover, PN 25

Item-No.:	Conn.:	Ball-passage:	Thread length:		Length:				Packing unit:
			t1	t2	L	Ø	H	LH	
53060 9	3/8"	10	9	9	47	23,5	44	96	12/240
53061 6	1/2"	14,5	13	13	58,5	29	56	96	-/-
53062 3	3/4"	19	14	14	65	36	59,5	96	-/-
53063 0	1"	24	17	17	74	42,5	68,5	112	-/-
53064 7	1 1/4"	32	17	17	90	55	87,5	112	-/-
53065 4	1 1/2"	40	19	19	101	69	94	140	-/-
53066 1	2"	50	20	20	118	84,5	112,2	140	-/-
as above, but without GKP									
S-2445	1 1/4"	31	15,5	17	90	55	76	125	4/ 40



F x M, full flow, steel lever with plastic cover

Item-No.:	Conn.:	Ball-passage:	Thread length:		Length:				Packing unit:
			t1	t2	L	Ø	H	LH	
53060-R	3/8"	9	8	8	44,5	22,5	43,1	83	12/120
53061-R	1/2"	13,5	10,5	10	54,5	27	46,9	93	10/ 80
53062-R	3/4"	18	12	11	61	34	50,2	93	10/ 60
53063-R	1"	23	14,5	11	70,5	41,5	58,3	116	6/ 36
53064-R	1 1/4"	30	15,5	14	85	53	73	135	4/ 24
53065-R	1 1/2"	38	17,5	15	97,5	65,5	79	135	4/ 16
53066-R	2"	47	18,5	17	114	78,5	90,5	151,5	2/ 8



F x M, optionally with red painted steel or aluminium lever

Item-No.:	Item-No.:	Conn.:	Ball-passage:	Thread length:		Length:				Packing unit:	
				t1	t2	L	Ø	H	LH	Lever steel	Lever alu
53189 7	-	1/4"	10	9	9	46,7	23,5	36	75,5	12/120	-/-
53190 3	53050 0	3/8"	10	9	9	47,2	23,5	36	77	12/120	12/120
53191 0	53051 7	1/2"	14,5	13	13	58,5	29	40,5	77	10/ 80	10/ 80
53192 7	53052 4	3/4"	19	14	14	64,5	36	49	97	10/ 60	10/ 60
53193 4	53053 1	1"	24	17	17	74	42,5	52	117	6/ 36	6/ 36
53194 1	53054 8	1 1/4"	31	17	17	90	55	65	140	4/ 20	4/ 24
53195 8	53055 5	1 1/2"	40	19	19	101	69	72	140	2/ 16	2/ 16
53196 5	53056 2	2"	50	20	20	118	84,5	87	160	2/ 8	2/ 8



Ball valve

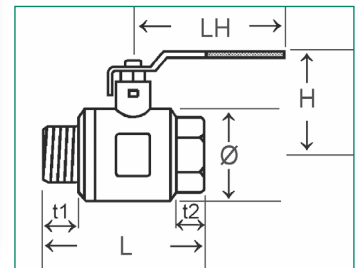
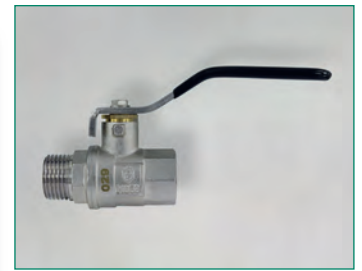

Ball valve ACS

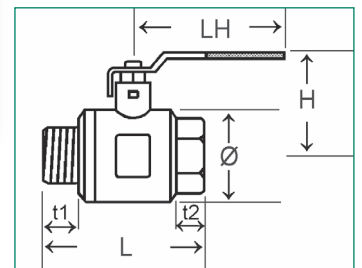
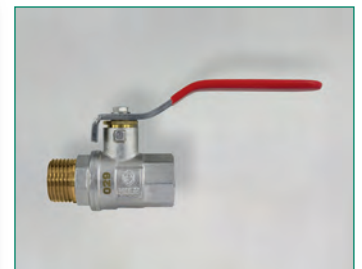

Ball valve

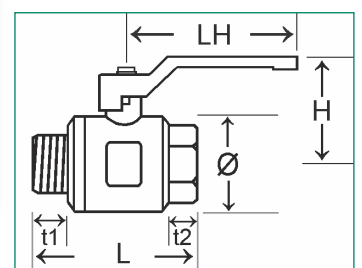

Ball valve

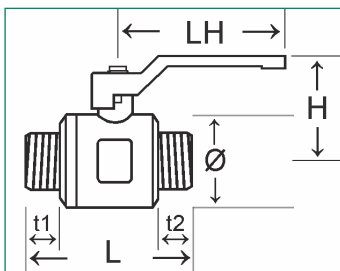
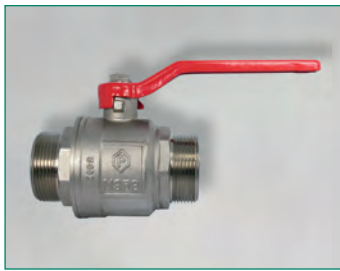

M x M, full passage, red painted steel- or aluminium lever

Item-No.:	Item-No.:	Conn.:	Ball-pas-sage:	Thread length:		Length:				Packing unit:
				t1	t2	L	Ø	H	LH	
Lever red steel	Lever red alu									
53290 0	-	3/8"	10	9	9	54	23,5	36	77	12/120
53291 7	53161 3	1/2"	14,5	13	13	66	29	40,5	77	10/ 60
53292 4	53162 0	3/4"	19	14	14	72	36	49	97	10/ 40
53293 1	53163 7	1"	24	17	17	86	42,5	52	117	6/ 36
53294 8	53164 4	1 1/4"	32	17	17	99	55	65	140	4/ 16
53295 5	53165 1	1 1/2"	40	19	19	109,5	69	72	140	2/ 12
53296 2	53166 8	2"	50	20	20	127	84,5	87	160	2/ 8



Ball valve ACS

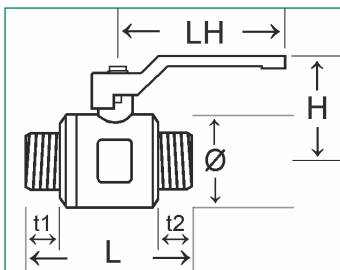
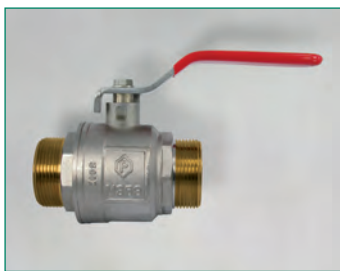

M x M, full passage, steel lever with red plastic cover

Item-No.:	Conn.:	Ball-pas-sage:	Thread length:		Length:				Packing unit:
			t1	t2	L	Ø	H	LH	
53290-R	3/8"	9	8	8	48,5	22,5	36	83	12/120
53291-R	1/2"	13,5	10,5	10,5	58,5	27	40,5	93	10/ 60
53292-R	3/4"	18	12	12	65,5	34	49	93	10/ 40
53293-R	1"	23	14,5	14,5	78,5	41,5	52	116	6/ 36
53294-R	1 1/4"	30	15,5	15,5	93,5	53	65	135	4/ 16
53295-R	1 1/2"	40	17,5	17,5	105,5	65,5	72	135	2/ 12
53296-R	2"	47	18,5	18,5	123	78,5	87	151,5	2/ 8



Ball valve

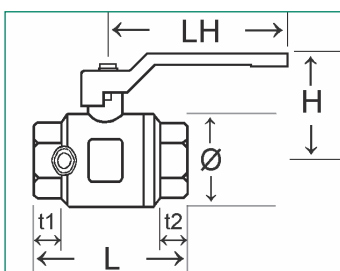

With drain, red painted steel lever mountable on both sides

Item-No.:	Conn.:	Ball-pas-sage:	Thread length:		Length:				Packing unit:
			t1	t2	L	Ø	H	LH	
53391 4	1/2"	14,5	12,5	12,5	54,5	29	40,5	75,5	8/64
53392 1	3/4"	19	12,5	12,5	60,5	36	49	97,5	6/48
53393 8	1"	24	13	13	68	42,5	52	118	4/32
53394 5	1 1/4"	32	15,5	15,5	81,5	55	65	140	5/20
53395 2	1 1/2"	40	16,5	16,5	92	69	72	140	3/ 12
53396 9	2"	50	19,5	19,5	110,5	84,5	87	160	2/ 8

Spare part: drain valve nickel plated

S-81	1/4"								-/-
------	------	--	--	--	--	--	--	--	-----



With drain, lever steel plastic cover red, mountable on both sides

Ball valve ACS

Item-No.:	Conn.:	Ball-pas-sage:	Thread length:		Length:				Packing unit:
			t1	t2	L	Ø	H	LH	
53391-R	1/2"	13,5	10	10	50,5	27	46,9	93	8/64
53392-R	3/4"	18	11	11	57	34	50,2	93	6/48
53393-R	1"	23	11	11	64,5	41,5	58,3	116	4/32
53394-R	1 1/4"	30	14	14	77	53	73	135	5/20
53395-R	1 1/2"	38	15	15	90	65,5	79	135	3/12
53396-R	2"	47	17	17	107,5	78,5	90,5	151,5	2/ 8
Spare part: drain valve nickel plated									
S-81	1/4"								-/-

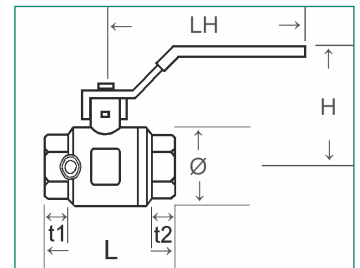

F x F, full flow, red or blue butterfly aluminum handle, PTFE ball seal, spindle seal 2 x O-ring FKM

Ball valve

Item-No.:	Item-No.:	Conn.:	Ball-pas-sage:	Thread length:		Length:				Packing unit:
				t1	t2	L	Ø	H	LH	
53020 3	-	3/8"	10	9,4	9,4	40	23,5	34,5	45	12/120
53029 6	-	1/4"	8	10	10	39,5	23,5	34	44	12/120
53021 0	-	1/2"	14,5	12,5	12,5	50	29	40,5	54	10/ 80
53022 7	53022-Blau	3/4"	19	12	12	54,5	36	44	54	10/ 60
53023 4	-	1"	24	13	13	63	42,5	48,5	62	6/ 36
53024 1	-	1 1/4"	31	15,5	15,5	77,5	55	59,5	75	2/ 30

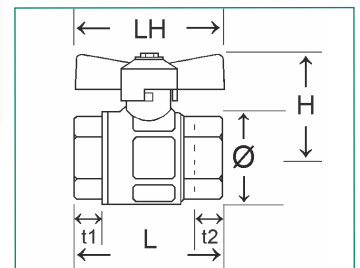

F x M, nickel plated, red or blue butterfly handle

Ball valve

Lever:	Item-No.:	Con.:	Least pass:	Thread length:		Length:				Packing unit:
				t1	t2	L	Ø	H	LH	
Lever red	53210 8	3/8"	10	9	9	46,5	23,5	38	45	12/120
Lever red	53211 5	1/2"	14,5	14	14	58	29	41,5	54	10/ 80
Lever red	53212 2	3/4"	19	14	14	64,5	36	46	54	10/ 60
Lever red	53213-40734	1"	23	13	13	68	42,5	47	62	8/ 40
Lever blue	53212-Blau	3/4"	19	14	14	64,5	36	46	54	10/ 60
Lever blue	53213-40734-Blau	1"	23	13	13	68	42,5	47	62	6/ 60
Set red/blue	53213-40734-R + B	1"	23	13	13	68	42,5	47	62	1/ 20
Lever red	53217 7	1 1/4"	31			90				-/-

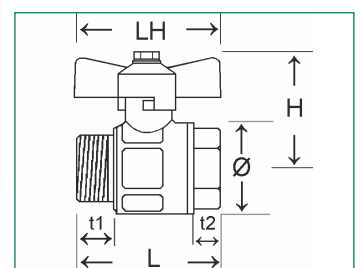

Ball valve

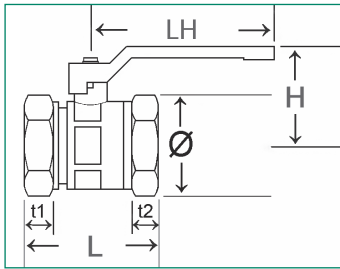
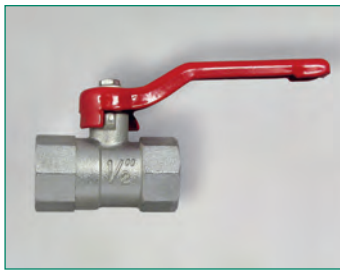

F x F, with reduced passage, spindle seal made of FKM

Item-No.:	Item-No.:	Conn.:	Ball-pas-sage:	Thread length:		Length:				Pack. unit:	Pack. unit:
				t1	t2	L	Ø	H	LH		
53041 8	-	1/2"	11	11	11	46,5	23,8	38	75,5	10/80	-/-
53042 5	53032 6	3/4"	15	12,5	12,5	54	29,8	45	75,5	10/60	10/80
53043 2	53033 3	1"	19	13,2	13,2	61	36,8	48	97,5	8/48	-/-
53044 9	-	1 1/4"	23	13,5	13,5	67	49,5	59	118	4/24	-/-
53045 6	-	1 1/2"	32	14,5	14,5	79	57,5	63,5	140	4/16	-/-
53046 3	-	2"	37	17	17	93	70,5	72	140	2/24	-/-



Ball valve

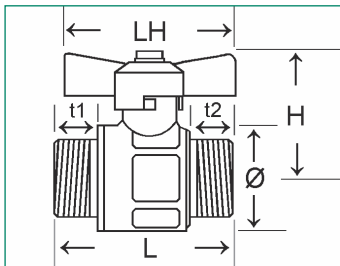

M x M, nickel plated, red butterfly handle of aluminium

Item-No.:	Conn.:	Ball-pas-sage:	Thread length:		Length:				Packing unit:
			t1	t2	L	Ø	H	LH	
53220 7	3/8"	10	9	9	54	23,5	34,4	44	12/240
53221 4	1/2"	14,5	13	13	66	29	40,5	55	10/ 80
53222 1	3/4"	19	14	14	72	36	44	55	10/ 60
53223 8	1"	24	17	17	86	42,5	48,3	61,5	6/ 60



Ball valve

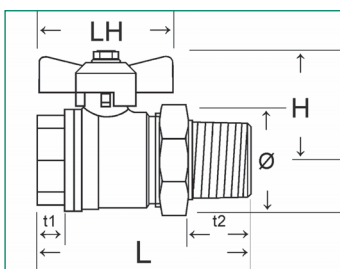

Nickel plated, one side female threaded, one side male threaded screw connection, red butterfly handle of aluminium

Item-No.:	Con.:	Least pass:	Thread length:		Length:				Pack. unit:	
			t1	t2	L	Ø	H	LH		
53380 8	male cylindrical	3/8"	10	10	10	59	23,5	38	44	10/100
53381 5	male cylindrical	1/2"	14,5	10	12	69	31,5	41	54	12/144
53382 2	male cylindrical	3/4"	18	10	14	72	48	60	54	10/ 40
53383 9	male cylindrical	1"	24	12,5	20	96	47,5	48	60	2/ 32
53383-11635-bl	male conical	1"	24	12,5	20	96	47,5	48	60	2/ 60



3-way ball valve

F x F, nickel plated, full flow, steel handle with black plastic cover

Item-No.:	Con.:	Ball-passage:	Thread length:		Length:					Pack. unit:
			t1	t2	L	Ø	H1	H2	LH	
T-form										
53421 8	1/2"	15	15	15	64	34	55	33	93	6/48
53422 5	3/4"	20	16	16	74	43	59	39	118	1/48
53423 2	1"	25	20	20	89	53	63	47	118	2/18
L-form										
53341 9	1/2"	15	15	15	64	34	55	33	93	1/72
53342 6	3/4"	20	16	16	74	43	59	39	118	1/48
53343 3	1"	25	20	20	89	53	63	47	118	1/32

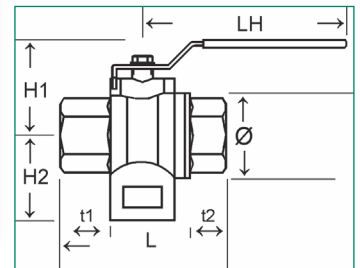

Angle ball valve

F x M, brass nickel plated, angular shape, screw connection with fixed O-ring, red or blue butterfly handle

Item-No.:	Conn.:	Ball-passage:	Thread length:		Length:				Packing unit:
			t1	t2	L	L1	H	LH	
S-031	1"	20	9	18	100	43	43	60	2/18
S-031-blau	1"	20	9	18	100	43	43	60	2/18

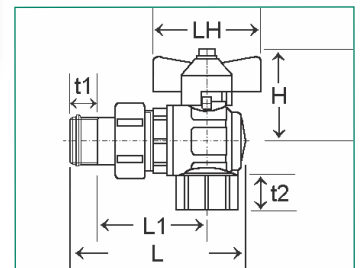

Angle ball valve

F x M, brass nickel plated, angular shape, red butterfly handle, DN 19

Item-No.:	Connection:	Ball-passage:	Thread length:		Length:				Packing unit:	
			t1	t2	L	L1	H	LH		
S-34	G 3/4" x G 1"	19	12	18	55,5	37	40	60	-/-	
as S-34, but with chamfer										
S-34-12100	G 3/4" x G 1"	19	12	18	55,5	37	40	60	6/48	
S-34-1	G 1" x G 1"	19	12	19,5	55,5	42	40	60	-/-	
as S-34-1, but short construction (handle red/blue/set red + blue)										
S-3945	G 1" x G 1"	16	9,5	12	47	32	44	55	-/48	
S-3945-b	G 1" x G 1"	16	9,5	12	47	32	44	55	-/48	
S-3945-R+B	G 1" x G 1"	16	9,5	12	47	32	44	55	-/24	

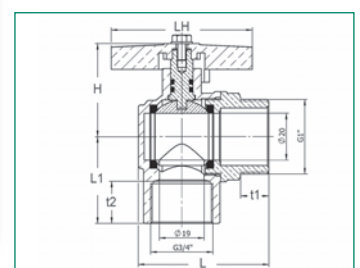

Angle ball valve

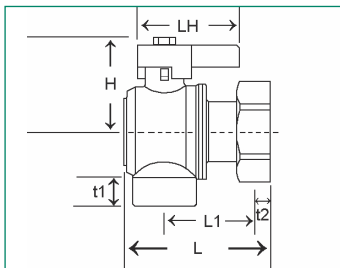

With union nut, F x F

	Item-No.:	Connection:	Least pass:	Thread-length:		Length:				Pack. unit:
				t1	t2	L	L1	H	LH	
Lever red	S-043	G 3/4" x 3/4"	13,5	11	11	50	34,5	36	52,5	-/72
Lever blue	S-043-blau	G 3/4" x 3/4"	13,5	11	11	50	34,5	36	52,5	-/72
Spare part butterfly handle of aluminium with sealing eye										
Lever red	53128-S043									-/-
Lever blue	53128-S043-B									-/-

With union nut, M x F (without illu.), ballpassage as stated above

	Item-No.:	Connection: m x f	t1	t2	L	L1	H	LH	Pack. unit:
Lever red	S-043-1"-AG	G1" M x 3/4" nut 22 mm		11	50	34,5	36	52,5	8/48
Lever blue	S-043-1"-AG-B	G1" M x 3/4" nut 22 mm		11	50	34,5	36	52,5	-/-

Angle ball valve

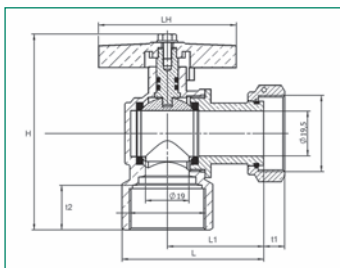

F x F, brass nickel plated, angular shape 42 mm, red/blue aluminium butterfly handle

Item-No.:	Item-No.:	Con.:	Ball-passage:	Thread-length:		Length:				Pack. unit:
				t1	t2	L	L1	H	LH	
Handle red	Handle blue									
S-3713-3/4-02	-	G 3/4" x G 1"	19	9	18	60,5	42	80	60	6/36
S-3713-02	S-3713-02-b	G 1" x G 1"	19	9	19,5	62	42	85	60	6/36

Angle ball valve

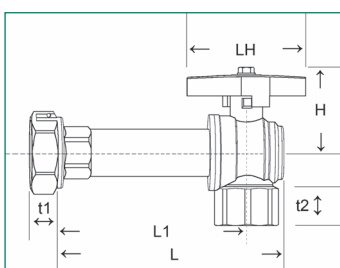

F x F, brass nickel plated, angular shape 100 mm, red/blue butterfly handle

Item-No.:	Item-No.:	Con.:	Ball-passage:	Thread-length:		Length:				Pack. unit:
				t1	t2	L	L1	H	LH	
Handle red	Handle blue									
53362 4	-	G 1" x G 3/4"	19	9	18	118,5	100	39,5	60	6/36
S-3713-01	S-3713-01-b	G 1" x G 1"	19	9	19,5	140	120		60	4/24

Angle ball valve

F x M, brass nickel plated, angular shape 97 mm, red butterfly handle

Item-No.:	Connection:	Ball-passage:	Thread-length:		Length:				Packing unit:
			t1	t2	L	L1	H	LH	
S-2596-1	G1" x G1"	19	12	19,5	115,5		39,7	60	-/-

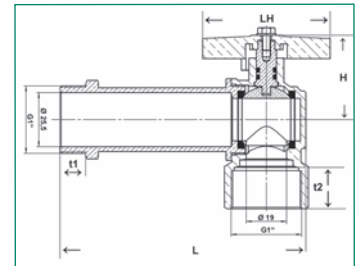
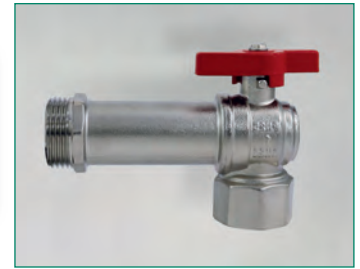

Item-No.:		Connection:	Pack. unit:
With square head, no handle			
54715-N	Air shut-off valve, CW617N plain	F/F 1 1/2"	1/ 8
54716-N	Air shut-off valve, CW617N plain	F/F 2"	1/ 8
With square head, with handle (as shown)			
54713-10939	Air shut-off valve, CW617N plain, right closing	F/F 1"	4/16
54713-b-10939	Air shut-off valve, CW617N plain, left closing	F/F 1"	4/16

Air shut-off valve

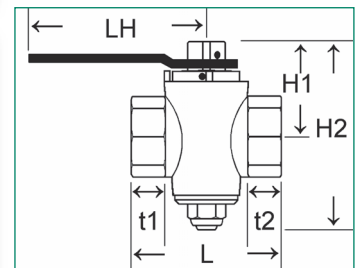

Item-No.:	Threadlength:		Length:				Wrench size	PN
	t1	t2	L	H1	H2	LH		
54715-N	23	23	110	70	138	-	22	6
54716-N	25	25	130	95	174	-	27	6
54713-10939	20	20	80	61	108,5	116	-	-
54713-b-10939	20	20	80	59,5	108,5	89	-	-

Replacement steel lever

Steel lever for air shut-off valve, nickel plated

Item-No.:	Wrench size:	Length:		Packing unit:
		L	H	
54719b-10939, short, for item-no. 54713b-10939	16	89		-/-
54719-10939, long, for item-no. 54713-10939	16	116		-/-

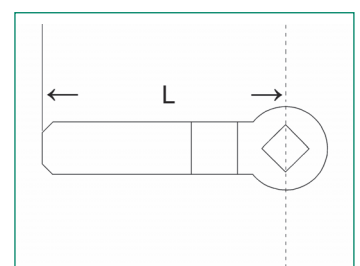

Replacement steel

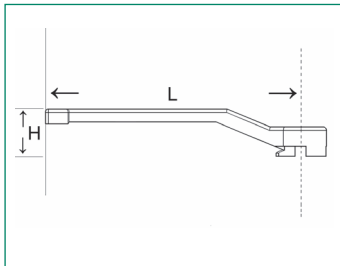
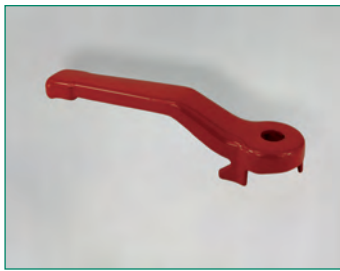

Steel lever, painted, red or blue

Item-No.:	Item-No.:	Conn.:	Length:		Packing unit:
			red	blue	
53100 2	53100-Blau	1/4"	75,5	21	-/100
53100 2	53100-Blau	3/8"	75,5	21	-/100
53102 6	53102-Blau	1/2"	97,5	26,5	-/100
53102 6	53102-Blau	3/4"	97,5	26,5	-/100
53103 3	53103-Blau	1"	118	26,5	-/ 50
53104 0	53104-Blau	1 1/4"	140	32,5	-/ 25
53104 0	53104-Blau	1 1/2"	140	32,5	-/ 25
53106 4	53106-Blau	2"	160	38,5	-/-
53107 1	53107-Blau	2 1/2"	202	37	-/100
53107 1	53107-Blau	3"	202	37	-/100
53109 5	53109-Blau	4"	250	41,5	-/-

Replacement aluminium lever

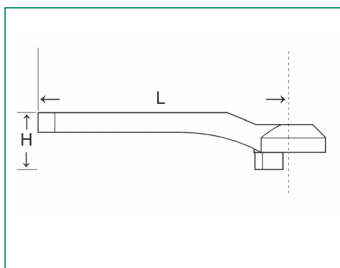

Aluminium lever, painted, red or blue

Item-No.:	Item-No.:	Conn.:	Length:		Packing unit:
			red	blue	
53110 1	53120 0	1/4"	76	18,2	-/-
53110 1	53120 0	3/8"	76	18,2	-/-
53111 8	53121 7	1/2"	76	18,2	-/-
53112 5	53122 4	3/4"	90	20,2	-/-
53113 2	53123 1	1"	90	20,2	-/100
53114 9	53124 8	1 1/4" + 1 1/2"	115,5	30	-/-
53116 3	53126 2	2"	130,5	32,5	-/ 50

Replacement aluminium lever

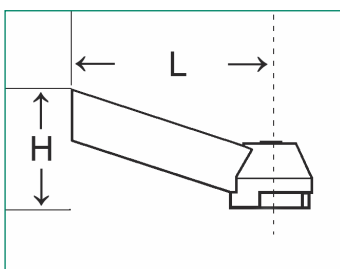

Aluminium lever, painted, red or blue (for item-no. 53271 + 53272), safety handle with blocking function

Item-No.:	Item-No.:	Conn.:	Length:		Packing unit:
			red	blue	
53271-R-Griff	53271-Griff	1/2" + 3/4"	56,5	34	-/-

Replacement steel lever

Steel lever with coat, red or black

Item-No.:	Item-No.:	Conn.:	Length:		Packing unit:
			L	H	
red	black				
53130-R	53130 9	1/4"	83	19,5	-/-
53130-R	53130 9	3/8"	83	19,5	-/-
53131-R	53131 6	1/2"	98	27	-/-
53132-R	53132 3	3/4"	98	27	-/-
53133-R	53133 0	1"	114	31	-/-
53134-R	53134 7	1 1/4"	124	30,5	-/50
53135-R	53135 4	1 1/4" + 1 1/2"	124	30,5	-/50
53136-R	53136 1	2"	143	36	-/-

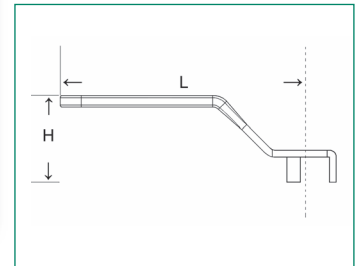

Replacement stainless steel lever

Stainless steel lever (1.4301) with coat, black

Item-No.:	Item-No.:	Conn.:	Length:		Packing unit:
			L	H	
red	black				
-	53130-VA	1/4"	83	19,5	-/-
-	53130-VA	3/8"	83	19,5	-/-
-	53131-VA	1/2"	98	27	-/-
-	53131-VA	3/4"	98	27	-/-
-	53133-VA	1"	114	31	-/-
-	53134-VA	1 1/4" + 1 1/2"	124	30,5	-/50
-	53134-VA	1 1/4" + 1 1/2"	124	30,5	-/50
-	53136-VA	2"	143	36	-/-

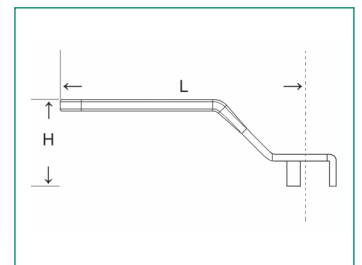

Replacement aluminium butterfly handle

Aluminium butterfly handle, painted, red or blue

Item-No.:	Item-No.:	Conn.:	Length:		Packing unit:
			L	H	
red	blue				
53127 9	-	3/8"	44	18,8	-/-
53128 6	53128-Blau	1/2"	55	22	-/-
53128-1/2"	-	1/2"	47	22	-/-
53128 6	53128-Blau	3/4"	55	22	-/-
53129 3	-	1"	61,5	22,5	-/-
Aluminium bare, unpainted					
53128-bl		1/2" + 3/4"	55	22	-/-

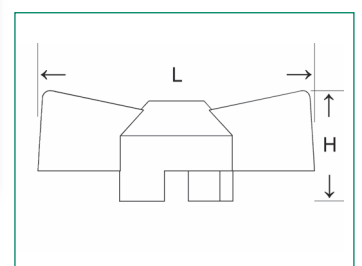

Replacement aluminium butterfly handle, flat

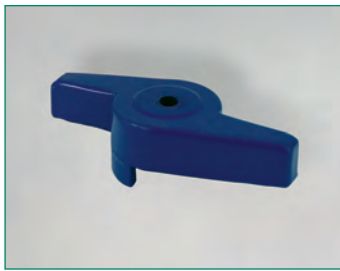

Aluminium butterfly handle, painted, red or blue

Item-No.:	Item-No.:	Conn.:	Length:		Packing unit:
			L	H	
red	blue				
53128-11658	53128-11658-blau	1/2" + 3/4"	60	16,5	-/-
53129-53373-Griff-r	53129-53373-Griff-b	1"	60		-/-

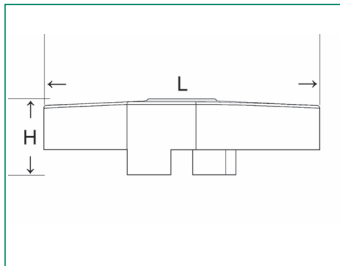

Replacement aluminium butterfly handle for S-043



Aluminium, red or blue

Item-No.:	Item-No.:	Conn.:	Length:		Packing unit:
			L	H	
red	blue				
53128-S043	53128-S043-B	1/2" + 3/4"	53	18,5	-/-

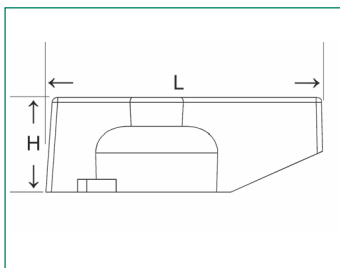

Replacement safety handle

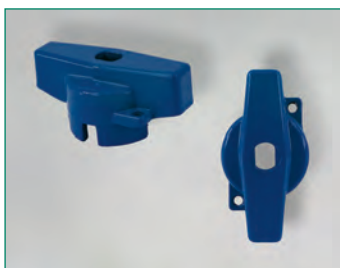

Aluminium, butterfly handle with blocking function and sealing hole, red or blue

Item-No.:	Item-No.:	Conn.:	Length:		Packing unit:
			L	H	
red	blue				
53128-5333x	53128-5333x-blau	1/2" + 3/4"	50	22	-/-

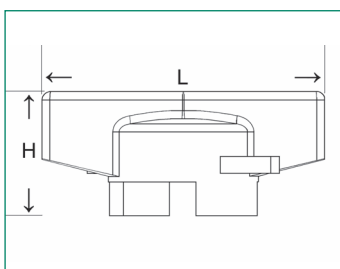

Replacement plastic handle

Plastic handle for mini ball valve, long, black, incl. brass screw

Item-No.:	Conn.:	Length:		Packing unit:
		L	H	
for example 53239-10880				
53239-10880-Griff	1/4"	73	38	-/100

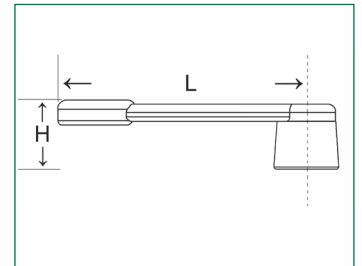

Replacement plastic handle

Plastic handle for ISO-T ball valve, black, PA 66, suitable for receiving a thermometer or a clip

Item-No.:	Conn.:	Length:		Packing unit:
		L	H	
53012-Griff	3/8" - 3/4"	63	48	-/300
53013-Griff M6	1"	83	51,5	-/360
53013-Griff-B M4	1"	83	51,5	-/360
53014-Griff	1 1/4" + 1 1/2"	100	55	-/180
53016-Griff	2"	110	57,5	-/168

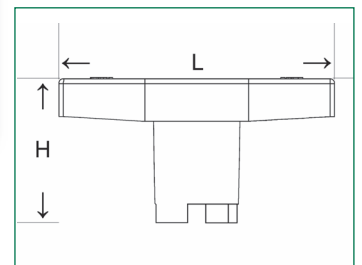

Clip for plastic handle

Clip for ISO-T ball valve, white, PA 66, printable

Item-No.:	Conn.:	Length:		Packing unit:
		L	B	
5301x-Clip-weiss		54,8	22,5	200/1000

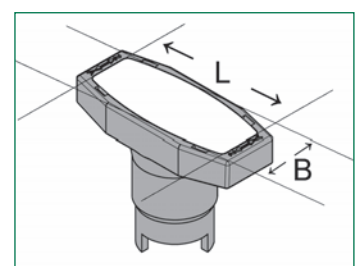

Ball valve

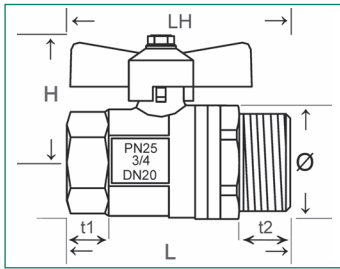

Red butterfly lever, F x M, PN 25, flat sealing, without sealing

Item-No.:	Conne.: F x M	Ball- passage:	Thread length:		Length:				Pack. unit:
			t1	t2	L	H	Ø	LH	
53283 2	3/4" x 1"	19	10,5	12,5	65	46	36	54	20/100
Seal for 53283									
49103 0	24 x 30 x 2 mm								

Ball valve

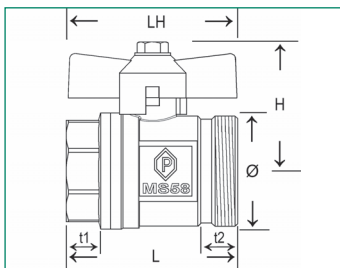

Brass nickel plated

Lever:	Item-No.:	Connection: F x M	Ball- pas- sage:	Thread length:		Length:				P. u.:
				t1	t2	L	Ø	H	LH	
Butterfly red	53214 6	G 3/4" x G 1 1/4"	19	12,5	14	60	33	45	54	-/-
Butterfly red	53215 3	G 1" x G 1 1/4"	24,5	12,8	8,5	56	42,5	50	61,5	-/-
Butterfly red	53216 0	G 1 1/2" x G 2"	40	13	18	103,5	70	72	84,5	-/-
Butterfly red	53217 7	G 1 1/4" x G 1 1/4"	31	15	15	90	51,5	62,5	75	-/-

Set with lever in red **and** blue

Flügelgriff	53214-R+B	G 3/4" x G 1 1/4"	19	12,5	14	60	33	45	54	-/24
Flügelgriff	53215-R+B	G 1" x G 1 1/4"	24,5	12	9,5	62	42,5	50	62	-/20
T-Griff	53216-R+B	G 1 1/2" x G 2"	40	13	18	103,5	70	72	84,5	-/ 6

as 53215, but male thread **conically sealing**

T-Griff rot	53218 4	G 1" x G 1 1/4"	24,5	12,8	8,5	56	42,5	50	61,5	-/-
T-Griff blau	53218-b	G 1" x G 1 1/4"	24,5	12,8	8,5	56	42,5	50	61,5	-/-

Set with lever in red **and** blue, male thread **conically sealing**

T-Griff	53218-R+B	G 1" x G 1 1/4"	24,5	12,8	8,5	56	42,5	50	61,5	1/20
---------	-----------	-----------------	------	------	-----	----	------	----	------	------

Spare seals, KTW-checked

	53214/5-AFM	27 x 38 x 2 mm								-/-
	53216-AFM	57 x 42 x 2 mm								-/-

Ball valve

F x M, nickel plated, flat sealing, red or blue butterfly handle

	Item-No.:	Conne.:	Ball-pas-sage:	Thread length:		Length:				Packing unit:
				t1	t2	L	Ø	H	LH	
		F x M								
Lever red	53287 0	3/4" x 3/4"	19	9	12	50	36	44	55	10/120
Lever red	53288 7	3/4" x 1"	19	9	12	50	36	44	55	10/120
Lever blue	53288-blau	3/4" x 1"	19	9	12	50	36	44	55	10/120
Set red/blue	53288-R+B	3/4" x 1"	19	9	12	50	36	44	55	1/ 30
Lever red	53289 4	1" x 1"	19	24	13	52	39	46	55	10/ 60

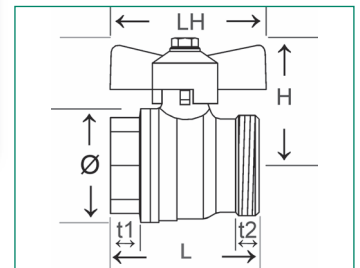

Ball valve

Nickel plated, full passage, blue butterfly handle, male thread/male thread

Item-No.:	Con.:	Ballpas-sage:	Thread length:		Length:				Packing unit:
			t1	t2	L	H	Ø	LH	
S-3904-B	1" x 1"	19	12	12	58	44	24,5	55	-/-

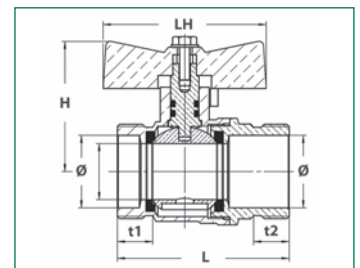

Ball valve

Nickel plated or plain, female thread/male thread, self-sealing screw connection with non-fixed O-ring of FKM, either red or blue butterfly handle

	Item-No.:	Item-No.:	Con.:	Least pass:	Thread length:		Length:				Pack. unit:
					t1	t2	L	Ø	H	LH	
	nickel plat.	plain									
Lever red	53373 0	53373-bl	1"	24	12	9	96	42,5	45	60	2/32
Lever blue	53373-Blau	53373-bl-Blau	1"	24	12	9	96	42,5	45	60	2/32
Spare parts:											
	53373-Dichtung	FKM		38 x 29,8 x 2 mm							
	53373-O-Ring	FKM		30 x 3,5 mm							

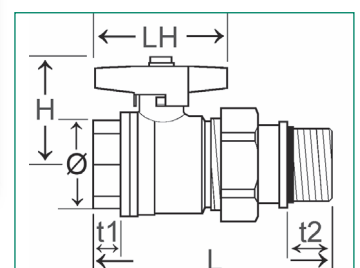

Ball valve

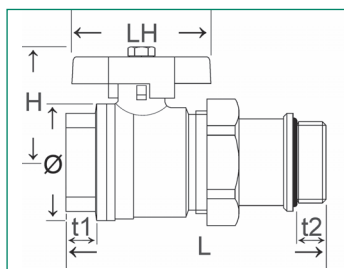

Nickel plated, self-sealing screw connection, O-ring (FKM) fixed, T-lever red or blue

Item-No.:	Connection: F x M	Least pass:	Thread length:		Length:				Pack. unit:
			t1	t2	L	Ø	H	LH	
53372-11658 (red)	G 3/4" x G 3/4"	18	12	8,5	80	36	44	55	10/40
53373-11658 (red)	G 1" x G 1"	24	12	9	96	42,5	45	60	2/32
53373-11658-blau	G 1" x G 1"	24	12	9	96	42,5	45	60	2/60
53374-11658 (red)	G 1 1/4" x G 1 1/4"	31	15	9	115	55	52	75	1/20
Set with lever red and blue									
53373-11658-R+B	G 1" x G 1"	24	12	9	96	42,5	45	60	-/-
Set with lever red and blue and stuffing box									
53373-40158-R+B	G 1" x G 1"	24	12	9	96	42,5	45	60	-/-
Replacement screw connection, O-ring fixed (FKM)									
53372-Verschraubung (EPDM80°A)	F G 1" x M G 3/4"								-/144
53373-Verschraubung	F G 1 1/4" x M G 1"								-/120
Replacement screw connection, O-ring fixed (EPDM80°A)									
S-3578	F G 3/4" x M G 3/4"								-/-

Replacement seals, FKM, no approval KTW/W270

Item-No.:	Connection:
53372-Dichtung	29 x 24 x 2 mm
53373-Dichtung	38 x 29,8 x 2 mm
53374-Dichtung	44,5 x 36,5 x 2,6 mm
53372-O-Ring	23 x 3 mm
53373-O-Ring	30 x 3,5 mm
53374-O-Ring	46 x 38 x 4 mm

Ball valve

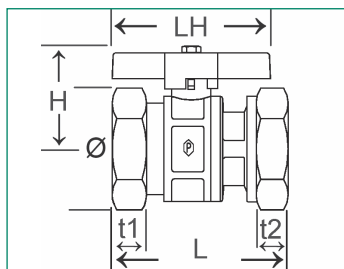

F x F, nickel plated or plain brass, reduced flow, red or blue butterfly handle, with union nut

Lever	Item-No.:	Item-No.:	Conn.:	Least pass:	Thread length:		Length:				Pack. unit:
					t1	t2	L	Ø	H	LH	
Red	53329 7	53329-bl	1" x 1"	16	12,8	13	60	36	38	60	10/40
Blue	53329-Blau	53329-bl-Blau	1" x 1"	16	12,8	13	60	36	38	60	10/40
as above, only lighter version											
Red	S-3923	-	1" x 1"	17,5	12	-	58	-	43	47	-/-
Blue	S-3923-b	-	1" x 1"	17,5	12	-	58	-	43	47	-/-
Set	S-3923-R+B	-	1" x 1"	17,5	12	-	58	-	43	47	-/-

Ball valve

F x F, nickel plated, with union nut

Item-No.:	Connection:	Least pass:	Thread length:		Length:				Pack. unit:
			t1	t2	L	Ø	H	LH	
with T-lever	F x F								
(illu.)	F x F								
S-2939	G1" x G1" x 22 mm	22	9	13,5	79,5	42,5	48	60	-/40
S-2939-1 1/4"	G1 1/4" x G1 1/4" x 32 mm	29	9,5		95	55	51	69	3/18
with long L-lever									
S-2939-1 1/2"	G1 1/2" x G1 1/2" x 40 mm	40	11	15	111	53	83	124	-/-
S-2939-2"	G2" x G2" x 50 mm	50	13	18,5	133	65	103	143	-/-

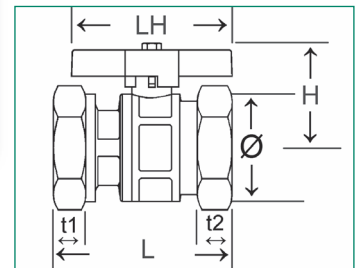

Ball valve

F x F, nickel plated, with union nut and connection for temperature sensors

Item-No.:	Connection:	Ball-passage:	Thread length:		Length:				P. u.:
			t1	t2	L	Ø	H	LH	
with T-lever	F x F								
(illustration)	F x F								
S-2939-1 1/4"-MF	G1 1/4" x G1 1/4" x 32 mm x M10 x 1	32	9,5	14,5	95	46	51	69	-/-
with L-lever (without illu.)									
S-2939-1 1/2"-MF	G1 1/2" x G1 1/2" x 40 mm x M10 x 1	34	11	15	111	53	83	124	-/-
S-2939-2"-MF	G2" x G2" x 50 mm x M10 x 1	45	13	18,5	133	65	103	143	-/-
Replacement seal for sensor system									
53322-D	14,6 x 10,3 x 1,5 mm								
Replacement plugs for ball valves with sensor connection									
53322-11	M10 x 1								

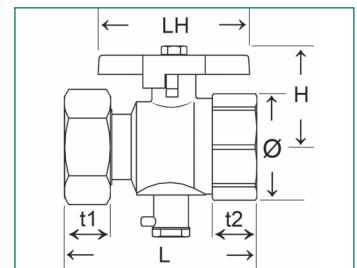

Ball valve

F x F, nickel plated, with union nut

Item-No.:	Connection:	Least pass:	Thread length:		Length:				Pack. unit:
			t1	t2	L	Ø	H	LH	
with T-lever	F x F								
S-3123-1-1 1/4"	G1" x G1 1/4" x 22 mm	22	9	12	75		48	60	-/32
S-3123-1 1/4"-1 1/2"	G1 1/4" x G1 1/2" x 32 mm	32	9,5	15,5	100	55	51	68,5	-/-
with plastic sheathed L-lever									
S-3123-1 1/2"-2"	G1 1/2" x G2" x 40 mm	40	13,5	15,5	120	69	58		-/-

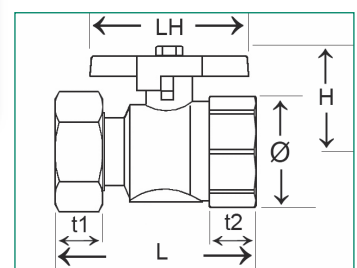

Ball valve

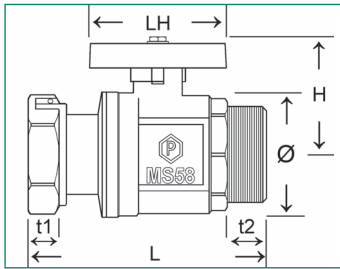

F x M, nickel plated, with union nut

Item-No.:	Connection:	Least pass:	Thread length:		Length:				Pack. unit:
			t1	t2	L	Ø	H	LH	
S-2983-1 1/4"	G1 1/4" x G1 1/4" x 32 mm	32	9,5	17	106	55	50	69,5	-/24
S-2983-1 1/4"-1 1/2"	G1 1/2" x G1 1/4" x 32 mm	32	9,5	17	108,5	55	50	69,5	-/25

Ball valve

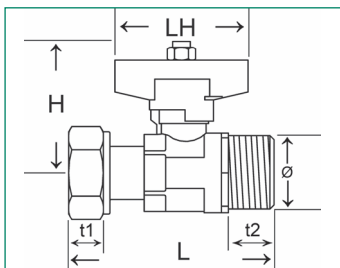

M x F, nickel plated, with union nut, red aluminum butterfly handle

Item-No.:		Conn.:	Least pass:	Thread length:		Length:				Pack. unit:
				t1	t2	L	Ø	H	LH	
53336 5	nick. pla.	3/4" x 1"	15		11	85,5	30	56	50	6/ 60
53336-bl	plain	3/4" x 1"	15		11	85,5	30	56	50	6/ 60
53337 2	nick. pla.	3/4" x 3/4"	15		12	76,4	30	51,5	51,5	10/120
53336-1"-1 1/4"	plain	1" x 1 1/4"	24		17	94	43,5	54,6	50	-/-

Ball valve

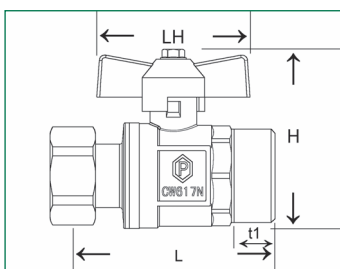

F x M, plain brass, full passage 16 mm, with union nut, **with** gravity brake, lever in red

Item-No.:	Connection:	Least pass:	Thread length:		Length:					Packing unit:
			t1	t2	L	Ø	H	H2	LH	
53378-R	G 3/4" x G 1"	16	14,5		71	16	64		55	5/40
53377-R	G 1" x G 1"	16	14,5		71	20	64		55	5/40

Ball valve

F x M, plain brass, full passage 20 mm, with union nut, **without** gravity brake, lever in red or blue

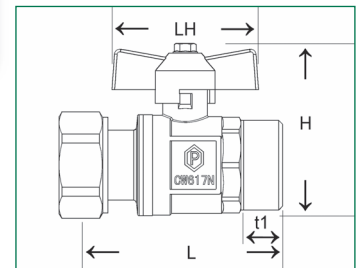

Item-No.:	Connection:	Least pass:	Thread length:		Length:					P.U.:
			t1	t2	L	Ø	H	H2	LH	
53379-R	G1" x G1"	20	14,5		71	20	64		55	5/40
53379-B	G1" x G1"	20	14,5		71	20	64		55	5/40

Ball valve

F x F, nickel plated, with union nut and sensor connection (M 10 x 1 mm), double O-ring

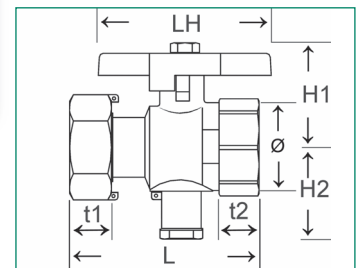

Item-No.:	Connection:	Least pass:	Thread length:		Length:					Pack. unit:
			t1	t2	L	Ø	H1	H2	LH	
53338 9	3/4" x 3/4" x M10/1 mm	13		12	67,5	29,5	36	31,5	60	10/60
53339 6	1" x 1" x M10/1 mm	20		12,7	75,5	29,5	36	31,5	60	-/-
Replacement seal for sensor system										
53322-D	10,6 x 14,5 x 2 mm									

Ball valve

F x F, nickel plated, with union nut and sensor connection (M10 x 1 mm), double O-ring, aluminium butterfly handle red or blue

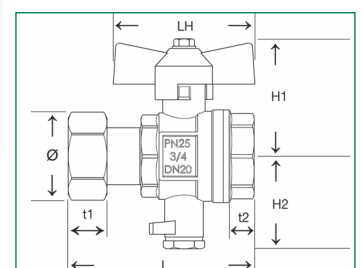

Item-No.:	Connection:	Least pass:	Thread length:		Length:					Pack. unit:
			t1	t2	L	Ø	H1	H2	LH	
S-3330-03-B	G3/4" x G3/4" x 16 mm	16					44	36	55	8/48
S-3330-03-R	G3/4" x G3/4" x 16 mm	16					44	36	55	8/48
Replacement seal for sensor system										
53322-D	10,6 x 14,5 x 2 mm									

Ball valve

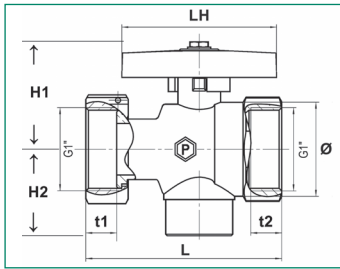

F x F, nickel plated, with union nut and sensor connection (1/2"), double O-ring

Item-No.:	Connection:	Least pass:	Thread length:		Length:					Pack. unit:
			t1	t2	L	Ø	H1	H2	LH	
53326 6	F x F	20	14	12,5	64	42,5	36	33,5	60	-/36
Replacement seal for sensor system										
53322-D	10,6 x 14,5 x 2 mm									

Ball valve

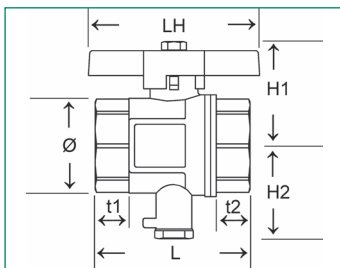

F x F, nickel plated, with sensor connection (M10 x 1 mm), double O-ring

Item-No.:	Connection:	Least pass:	Thread length:		Length:					Pack. unit:
			t1	t2	L	Ø	H1	H2	LH	
Aluminium butterfly handle										
with red plastic cover										
53321 1	G1/2" x G1/2" x M10 x 1 mm	15	17,5	17,5	64	31	31,5	40	60	10/60
53322 8	G3/4" x G3/4" x M10 x 1 mm	19	12,5	12,5	55,5	36	44	45	60	10/60
53323 5	1" x 1" x M10/1 mm	24	12,8	12,8	63	36	52	44	60	8/ 40
Replacement seal for sensor system										
53322-D	10,6 x 14,5 x 2 mm									

Ball valve

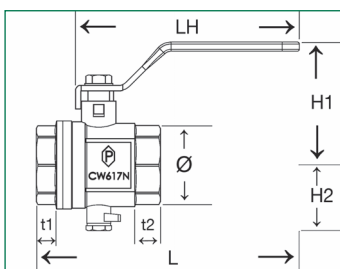

F x F, nickel plated, with sensor connection (M10 x 1 mm), double O-ring

Item-No.:	Connection:	Ball-passage:	Thread length:		Length:					Pack. unit:
			t1	t2	L	Ø	H1	H2	LH	
Steel lever										
with red plastic coating										
53324 2	G1 1/4" x G1 1/4" x M10 x 1 mm	32	15	15	77	55	73,5	36	114	4/24
53325 9	G1 1/2" x G1 1/2" x M10 x 1 mm	40	16	16	90	69	82,5	42	124	2/ 12
53328 0	G2" x G2" x M10 x 1 mm	50	19,5	19,5	109	84,5	102,5	49	143	2/ 8
Replacement seal for sensor system										
53322-D	10,6 x 14,5 x 2 mm									

F x F, nickel plated, for diverse adapters for various commercially available sensor systems (M 10 x 1 mm), red butterfly handle

Ball valve for adapter

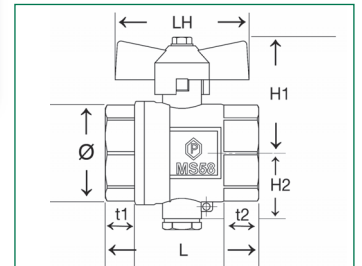

Item-No.:	Connection:	Ball-pas-sage:	Thread-length:		Length:					Pack. unit:
			t1	t2	L	Ø	H1	H2	LH	
53322-11727	F x F	19	12	12	55	36	44	23,5	55	10/60
Replacement seal for sensor system										
53322-D	10,6 x 14,5 x 2 mm									

M x F, plain brass

Adapter reducing nipple



Item-No.:	Connection:	Packing unit:
53322-11727-01	M 10 x 1 mm x M 10 x 1 mm	-/-

Plain brass, male thread/male thread

Adapter nipple



Item-No.:	Connection:	Packing unit:
53322-11727-02	M 10 x 1 mm x M 12 x 1,5 mm	-/-

Plain brass, with O-ring

Adapter plug

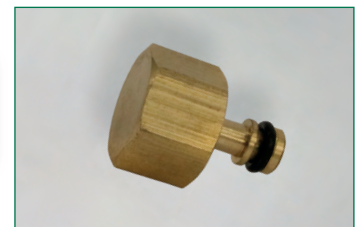

Item-No.:	Connection:	Packing unit:
53322-11727-03	M 12 x 1,5 mm	-/-

53322-11727-02 fitted with 53322-11727-03

Adapter combination

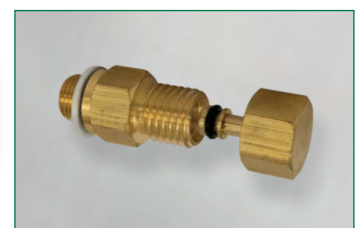

Item-No.:	Connection:	Packing unit:
53322-11727-04	M 10 x 1 mm x M 12 x 1,5 mm	-/-

Ball valve

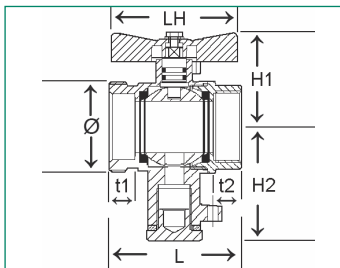

F x M, nickel plated, with sensor connection (M10 x 1 mm), **red handle**

Item-No.:	Connection:	Ball-pas-sage:	Thread length:		Length:					Pack. unit:
			t1	t2	L	Ø	H1	H2	LH	
53323-11555	G3/4" x G1" x M10 x 1 mm	19	9,5	12	50	36	44	34	55	6/54
Nickel plated, with sensor connection (M10 x 1 mm), F/M, flat sealing, red handle										
S-3082-5-R	G3/4" x G1" x M10 x 1 mm	19	9,5	12	50	36	44	34	55	-/72
Nickel plated, with sensor connection (M10 x 1 mm), F/M, flat sealing, blue handle										
S-3082-5-B	G3/4" x G1" x M10 x 1 mm	19	9,5	12	50	36	44	34	55	6/54
Replacement seal for sensor system										
53322-D	10,6 x 14,5 x 2 mm									

Ball valve

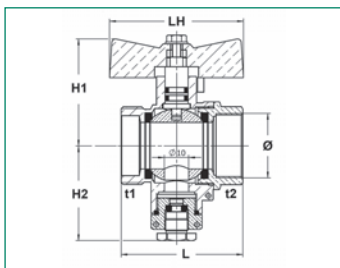

M x F, nickel plated, with double sensor connection (M10 x 1 mm), alu-handle red or blue

Item-No.:	Connection:	Ball-pas-sage:	Thread length:		Length:					Pack. unit:
			t1	t2	L	Ø	H1	H2	LH	
Alu-handle (red/blue)										
S-3670-04	G3/4" x G1" x G3/8" x M10 x 1 mm	19	9,5	12	50	24,5	44	39	55	6/54
S-3670-04-b	G3/4" x G1" x G3/8" x M10 x 1 mm	19	9,5	12	50	24,5	44	39	55	6/54
S-3903	G1" x G1" x G3/8" x M10 x 1 mm	19	9,5	11,5	52	24,5	44	39	55	8/48
S-3903-b	G1" x G1" x G3/8" x M10 x 1 mm	19	9,5	11,5	52	24,5	44	39	55	8/48

Ball valve

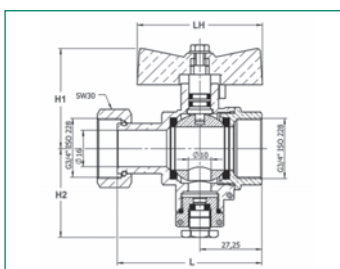

F x union nut, nickel plated, with double sensor connection (M10 x 1 mm), IG/ÜM, alu-handle red

Item-No.:	Connection:	Ball-pas-sage:	Thread length:		Length:					Pack. unit:
			t1	t2	L	Ø	H1	H2	LH	
Alu-handle red										
S-4044-01	G3/4" x G3/4" x G3/8" x M10 x 1 mm				63,5	16	44	39	55	-/-

Ball valve

F x M, plain brass, female thread, red butterfly handle, with screwed on extension with sensor connection (1/2")

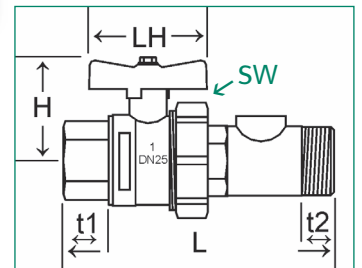

Item-No.:	Connection:	Least pass:	Threadlength:		Length:				Wre. size:	Pack. unit:
			t1	t2	L	H	SW	LH		
S-66	1" x 1/2" x 1"	25	24,5	16	131	52,5	52,5	62	4/32	

Immersion sleeve

Plain brass, universal immersion sleeve, sealing against countersink

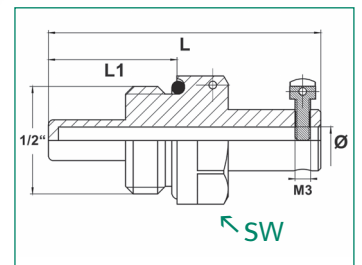
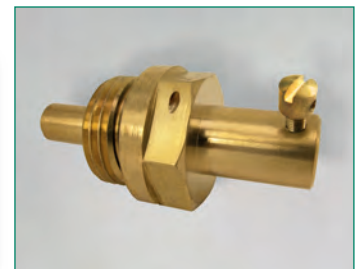

Item-No.:	Connection:	Length:		Wrench size:		Packing unit:
		L	L1	SW	Ø	
S-1244	1/2" M	53	25	22	5,2	-/240

Ball valve

F x F, for the installation of water meters, nickel plated, with sealing eye, with union nut, safety grip with blocking function and sealing eye, stuffing box

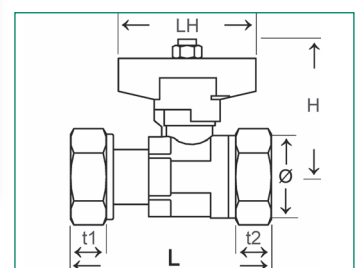

Item-No.:	Item-No.:	Connection:	Least pass:	Thread length:		Length:				Packing unit:
				t1	t2	L	Ø	H	LH	
53330 3	-	1/2" x 1/2"	15		17		32,5	51,5	50	-/-
53331 0	-	1/2" x 3/4"	14		17	73	32,5	51,5	50	10/60
53332 7	53332-Blau	3/4" x 3/4"	14		18	76	32,5	51,5	50	10/60
53333 4	-	3/4" x 1"	15		18	78	32,5	50,5	50	8/48
53334 1	-	1" x 1"	19		14	83	39,5	56	50	8/40

Ball valve

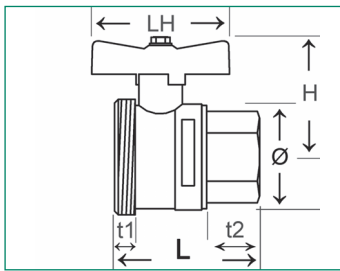

F x M, plain brass, red butterfly handle, stuffing box, heavy version

Item-No.:	Connection:	Ball-passage:	Thread length:		Length:				Packing unit:
			t1	t2	L	Ø	H	LH	
S-48	1" x M47 x 1,5	25	8	24,5	60	44	52,5	62	8/ 48
Accessories: union nut brass (without illu.)					WS				
S-69	M47 x 1,5		15,5	-	19	52	-	-	25/300

Ball valve

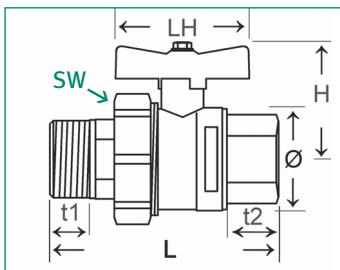

Plain brass, one side female thread/one side male threaded screw connector, red butterfly handle, stuffing box, heavy version

Item-No.:	Connection:	Least pass:	Thread length:		Length:		Wre. size:		Pack. unit:
			t1	t2	L	H	SW	LH	
S-63	1" x R1"	25	17	24,5	98	52,5	52,5	62	2/40
	Connection M47 x 1,5								

Ball valve

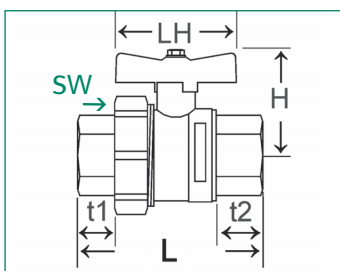

Plain brass, one side female thread/one side female threaded screw connector, red butterfly handle, stuffing box, heavy version

Item-No.:	Connection:	Least pass:	Thread length:		Length:			Wrench size:	Pack. unit:
			t1	t2	L	H	LH	SW	
S-64	1" x 1"	25	17	24	87	52,5	62	52,5	4/40
	Connection M47 x 1,5								

Ball valve

Plain brass, screw connectors on both sides male thread/female thread, red butterfly handle, stuffing box, heavy version

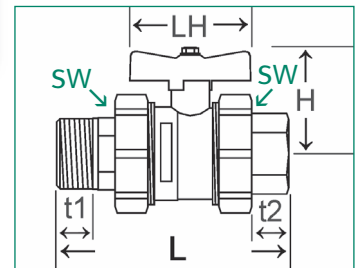
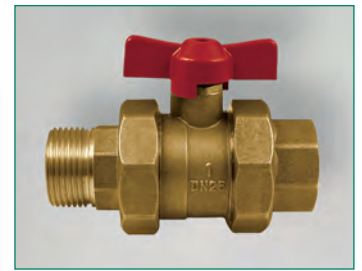

Item-No.:	Connection:	Least pass:	Thread-length:		Length:		Wrench size:		Pack. unit:
			t1	t2	L	H	SW	LH	
S-65	R1" x 1"	25	17	16	109	52,5	52,5	62	4/24
	Connection M 47 x 1,5								

Ball valve

Nickel plated, with compression fittings, red aluminium butterfly handle

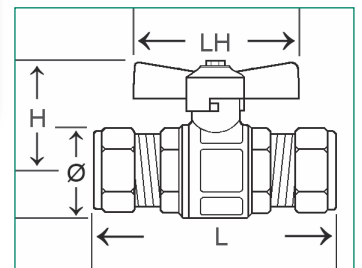

Item-No.:	Conn.:	Least pass:	Length:				Packing unit:
			L	Ø	H	LH	
53351 8	15 mm	14,5	75	29	43	62	10/ 60
53353 2	22 mm	19	83	36	45	62	10/120
53354 9	28 mm	24	96	42,5	55	62	6/ 60
53355 6	35 mm	31	120	55	61,5	62	3/ 24

Ball valve

Nickel plated, with compression fittings, steel handle with red plastic coating

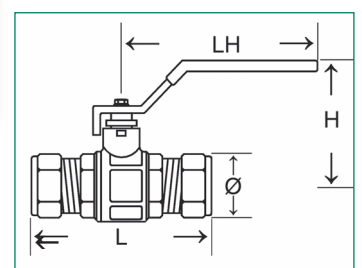

Item-No.:	Conn.:	Ball-passage:	Length:				Packing unit:
			L	Ø	H	LH	
53361 7	15 mm	14,5	75	29	55	99	10/100
53363 1	22 mm	19	83	36	58	99	10/ 80
53364 8	28 mm	24	96	42,5	68,5	115,5	6/ 24
53365 5	35 mm	31	120	55	73	125	4/ 32

Ball valve, PN 40

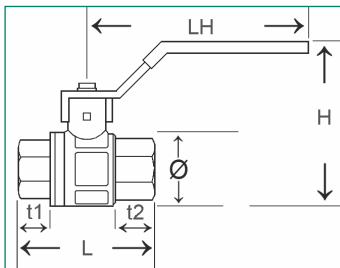

F x F (long), brass nickel plated, steel lever with red plastic coating, stuffing box/O-ring, thread according to DIN ISO 7-1

Item-No.:	Conn.:	Ball-pas- sage:	Thread length:		Length:				PN	Packing unit:
			t1	t2	L	Ø	H	LH		
53439 3	1/4"		13	13	48	24	40	80	40	-/-
53430 0	3/8"		13	13	48	24	40	80	40	12/180
53431 7	1/2"	14,5	17	17	61	29,5	40	95	40	10/120
53432 4	3/4"	19	19	19	70	36	40	95	32	10/ 80
53433 1	1"	24	23	23	84	44	40	110	32	6/ 48
53434 8	1 1/4"	32	24	24	98	57,5	40	130	25	2/ 32
53435 5	1 1/2"	40	25	25	108	70	40	130	20	2/ 20
53436 2	2"	50	29	29	130	85,5	40	150	16	2/ 16

Ball valve, PN 40

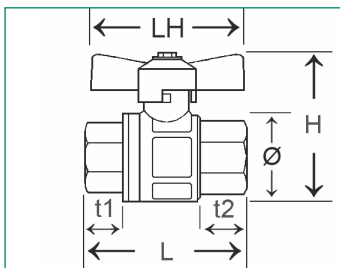

F x F (long), brass nickel plated, with red butterfly handle, stuffing box/O-ring, thread according to DIN ISO 7-1

Item-No.:	Conn.:	Ball-pas- sage:	Thread length:		Length:				PN	Packing unit:
			t1	t2	L	Ø	H	LH		
53450 8	3/8"		13	13	48	24		45	40	
53451 5	1/2"	14,5	17	17	61	29,5		54	40	
53452 2	3/4"	19	19	19	70	36		54	40	
53453 9	1"	24	23	23	84	44		62	40	

Ball valve

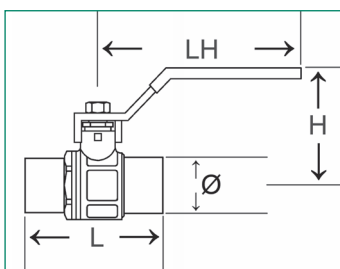
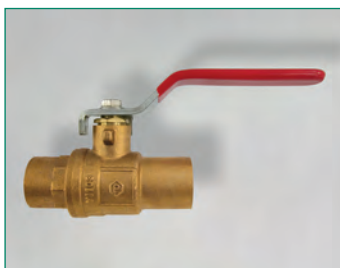

Plain brass, steel handle with red plastic coating, stuffing box, both sides with solder connections

Item-No.:	Conne- c.:	Ball- pas- sage:	Length:				Packing unit:
			L	Ø	H	LH	
56321 8	15 mm	12	56	28	52,5	99	10/80
56322 5	18 mm	14,5	65	30,5	56	99	10/60
56323 2	22 mm	17	79	34,5	65	114	8/48
56324 9	28 mm	22	96	47	68,5	114	6/36

Allgas socket

For connection of gas stoves, brass nickel plated, with TAE, DIN DVGW, R 1/2" M x quick lock, thermal fuse, max. operating pressure 100 mbar, max. operating temperatur 80°C, HTB-consistent

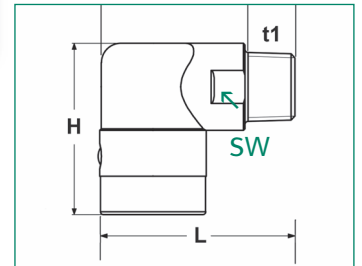

Item-No.:	Connec.:	Length:		Thread length: t1	Wrench size: SW	Packing unit:
		L	H			
67301 6	Rp 1/2"	60	53	16	25	20/60

Safety gas hose

According to EN14800, DIN DVGW, Rp 1/2" F x standard plug, according to DIN 3383

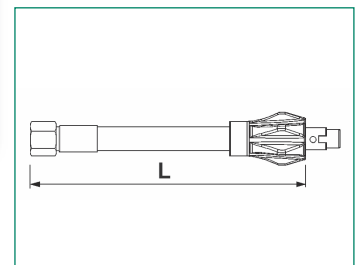

Item-No.:	Conn.: Length L	Packing unit:
67310 8	500 mm	1/50
67311 5	750 mm	1/50
67312 2	1000 mm	1/50
67313 9	1250 mm	1/50
67314 6	1500 mm	1/40
67315 3	2000 mm	1/35

Ball valve brass DIN-DVGW gas, F/F

F x F, nickel plated, with yellow coated steel handle

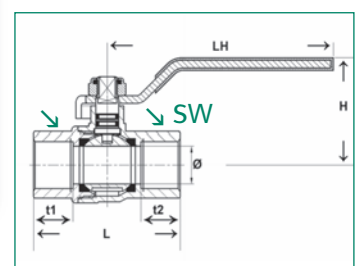

Item-No.:	Conn.: Rp/Rp	Ball-pas-sage: Ø	Thread length:		Length:		Wrench size:		Pack. unit:
			t1	t2	L	H	SW	LH	
67151 7	1/2"	15	15,5	15,5	58	42	25	89	8/64
67152 4	3/4"	20	17	17	67	46	31	89	6/36
67153 1	1"	25	20	22,5	81	60	38	112	2/20
67154 8	1 1/4"	30,5	23	23,5	95	70	47	131	2/18
67155 5	1 1/2"	38,5	23	23	103	72	53	131	2/12
67156 2	2"	47,5	28	28	126	83	66	160	2/6

Ball valve brass DIN-DVGW gas, M/F

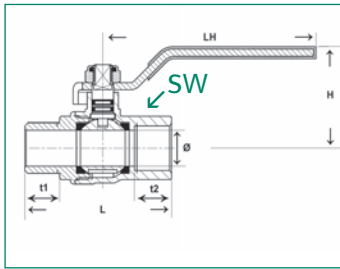

M x F, nickel plated, with yellow coated **steel handle**

Item-No.:	Conn.:	Ball-pas-sage:	Thread length:		Length:		Wrench size:		Pack. unit:
			t1	t2	L	H	SW	LH	
67251 4	1/2"	15	15,5	14,5	61	42		89	-/-
67252 1	3/4"	20	17	16	70	46		89	-/-
67253 8	1"	25	20	19,5	84	60		112	-/-
67254 5	1 1/4"	30,5	23	20,5	97	70		131	-/-
67255 2	1 1/2"	38,5	23	21,5	111	72		131	-/-
67256 9	2"	47,5	28	26,2	137	83		160	-/-

Ball valve brass DIN-DVGW gas, M/M

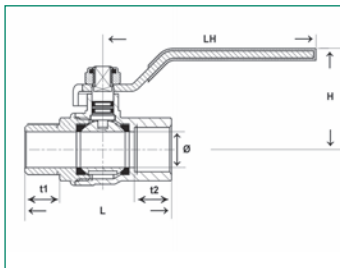

M x M, nickel plated, with yellow coated **steel handle**

Item-No.:	Conn.:	Ball-pas-sage:	Thread length:		Length:		Wrench size:		Pack. unit:
			t1	t2	L	H	SW	LH	
67351 1	1/2"	15	14,5	14,5	60	42		89	-/-
67352 8	3/4"	20	16	16	69	46		89	-/-
67353 5	1"	25	19,5	19,5	83	60		112	-/-
67354 2	1 1/4"	30,5	20,5	20,5	95	70		131	-/-
67355 9	1 1/2"	38,5	21,5	21,5	111	72		131	-/-
67356 6	2"	47,5	26,2	26,2	135	83		160	-/-

Ball valve brass DIN-DVGW gas, F/F

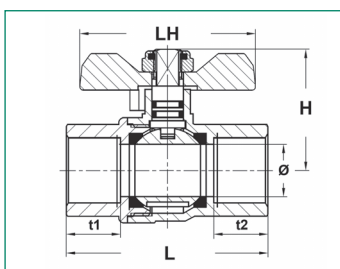

F x F, nickel plated, with yellow coated **butterfly handle**

Item-No.:	Conn.:	Ball-pas-sage:	Thread length:		Length:		Wrench size:		VE:
			t1	t2	L	H	SW	LH	
67451 8	1/2"	15	15,5	15,5	58	35		50	8/64
67452 5	3/4"	20	17	17	67	39		50	6/36
67453 2	1"	25	22,5	20	81	48		67	2/20

Ball valve brass DIN-DVGW gas, M/F

M x F, nickel plated, with yellow coated **butterfly handle**

Item-No.:	Conn.:	Ball-pas-sage:	Thread length:		Length:		Wrench size:		VE:
			Ø	t1	t2	L	H	SW	
67551 5	1/2"	15	14,5	15,5	61	35		50	-/-
67552 2	3/4"	20	16	17	70	39		50	-/-
67553 9	1"	25	19,5	20	84	48		67	-/-

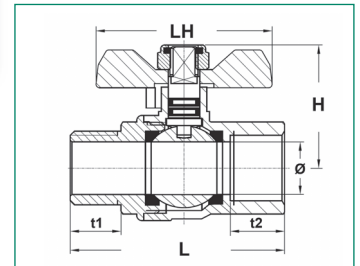

Ball valve brass DIN-DVGW gas, M/M

M x M, nickel plated, with yellow coated **butterfly handle**

Item-No.:	Conn.:	Ball-pas-sage:	Thread length:		Length:		Wrench size:		VE:
			Ø	t1	t2	L	H	SW	
67651 2	1/2"	15	14,5	14,5	60	40		52,5	-/-
67652 9	3/4"	20	16	16	69	45		52,5	-/-
67653 6	1"	25	19,5	19,5	83	54,5		65	-/-

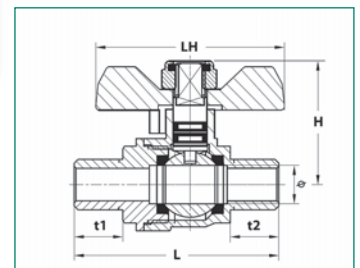

Ball valve brass DIN-DVGW water, F/F

F x F, nickel plated, with green coated **steel handle**

Item-No.:	Conn.:	Ball-pas-sage:	Thread length:		Length:		Wrench size:		Pack. unit:
			Ø	t1	t2	L	H	SW	
67161 6	1/2"	15	15,5	15,5	58	42	25	89	8/64
67162 3	3/4"	20	17	17	67	46	31	89	6/36
67163 0	1"	25	20	22,5	81	60	38	112	2/20
67164 7	1 1/4"	30,5	23	23,5	95	70	47	131	2/18
67165 4	1 1/2"	38,5	23	23	103	72	53	131	2/12
67166 1	2"	47,5	28	28	126	83	66	160	2/6

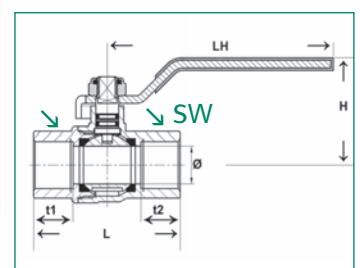

Ball valve brass DIN-DVGW water, M/F

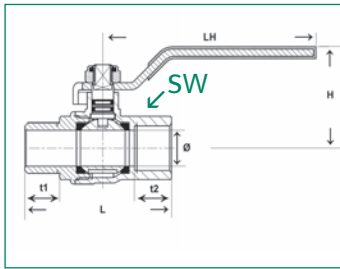
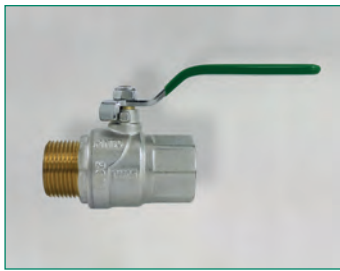

M x F, nickel plated, with green coated **steel handle**

Item-No.:	Conn.:	Ball-pas-sage:	Thread-length:		Length:		Wrench size:		Pack. unit:
			t1	t2	L	H	SW	LH	
67261 3	1/2"	15	15,5	14,5	61	42		89	-/-
67262 0	3/4"	20	17	16	70	46		89	-/-
67263 7	1"	25	20	19,5	84	60		112	-/-
67264 4	1 1/4"	30,5	23	20,5	97	70		131	-/-
67265 1	1 1/2"	38,5	23	21,5	111	72		131	-/-
67266 8	2"	47,5	28	26,2	137	83		160	-/-

Ball valve brass DIN-DVGW water, M/M

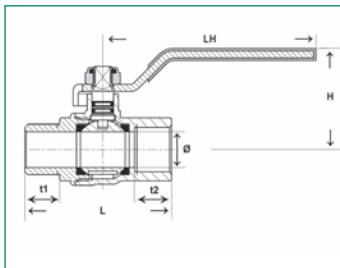
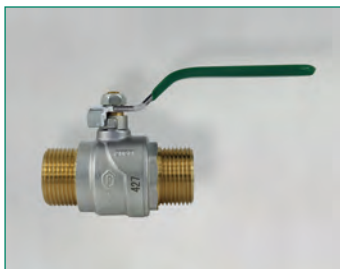

M x M, nickel plated, with green coated **steel handle**

Item-No.:	Conn.:	Ball-pas-sage:	Thread-length:		Length:		Wrench size:		Pack. unit:
			t1	t2	L	H	SW	LH	
67361 0	1/2"	15	14,5	14,5	60	42		89	-/-
67362 7	3/4"	20	16	16	69	46		89	-/-
67363 4	1"	25	19,5	19,5	83	60		112	-/-
67364 1	1 1/4"	30,5	20,5	20,5	95	70		131	-/-
67365 8	1 1/2"	38,5	21,5	21,5	111	72		131	-/-
67366 5	2"	47,5	26,2	26,2	135	83		160	-/-

Ball valve brass DIN-DVGW water, F/F

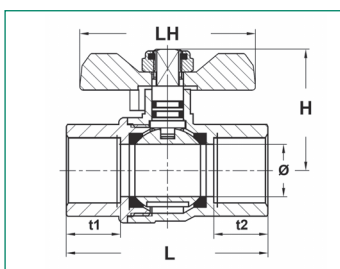

F x F, nickel plated, with green coated **butterfly handle**

Item-No.:	Conn.:	Ball-pas-sage:	Thread length:		Length:		Wrench size:		VE:
			t1	t2	L	H	SW	LH	
67461 7	1/2"	15	15,5	15,5	58	35		50	8/64
67462 4	3/4"	20	17	17	67	39		50	6/36
67463 1	1"	25	22,5	20	81	48		67	2/20

Ball valve brass DIN-DVGW water, M/F

M x F, nickel plated, with green coated **butterfly handle**

Item-No.:	Conn.:	Ball-pas-sage:	Thread length:		Length:		Wrench size:		VE:
			t1	t2	L	H	SW	LH	
67561 4	G/G	Ø	14,5	15,5	61	35		50	8/64
67562 1	1/2"	15	14,5	15,5	61	35		50	8/64
67562 1	3/4"	20	16	17	70	39		50	6/36
67563 8	1"	25	19,5	20	84	48		67	2/20

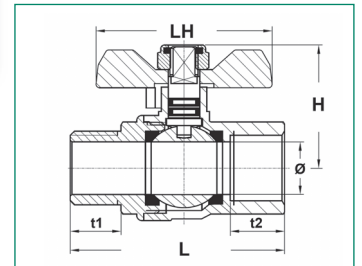

Ball valve brass DIN-DVGW water, M/M

M x M, nickel plated, with green coated **butterfly handle**

Item-No.:	Conn.:	Ball-pas-sage:	Thread length:		Length:		Wrench size:		VE:
			t1	t2	L	H	SW	LH	
67661 1	G/G	Ø	14,5	14,5	60	40		52,5	8/64
67661 1	1/2"	15	14,5	14,5	60	40		52,5	8/64
67662 8	3/4"	20	16	16	69	45		52,5	6/36
67663 5	1"	25	19,5	19,5	83	54,5		65	2/20

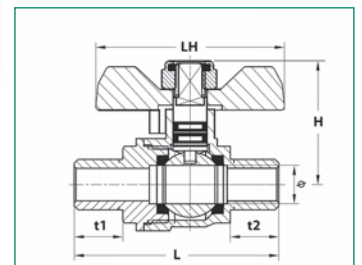

Brass mini ball valves, full flow, nickel plated, ball: brass hard chrome plated, ball seal made of PTFE; brass spindle, shaft seal made of FKM, for temperatures of – 20°C up to + 120°C, pressure stage for mini valves series: PN 10; material: brass according to DIN 50930-6, hot-pressed, cylindrical threads according to ISO 228-2.

(Valid for all mini ball valves, unless otherwise stated)

Mini ball valve

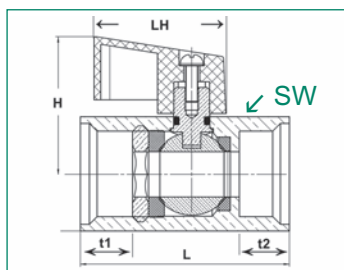
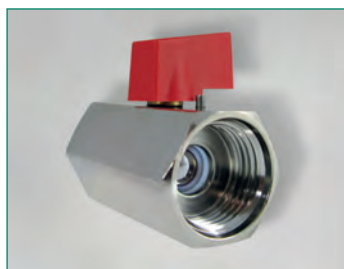

F x F, nickel plated, red plastic handle, external hexagon

Item-No.:	Conn.: F x F	Wrench size: SW	Ball-pas- sage:	Thread length:		Length:			Packing unit:
				t1	t2	L	H	LH	
53229 0	1/4"	21	8	10	9,5	40	28,3	-	25/150
53230 6	3/8"	21	8	10,5	10	40	28,3	-	25/150
53231 3	1/2"	25	10	11	11,5	46	30,1	-	20/120
53232 0	3/4"	30	14,5	14	13	54	32,6	-	14/ 70

Mini ball valve

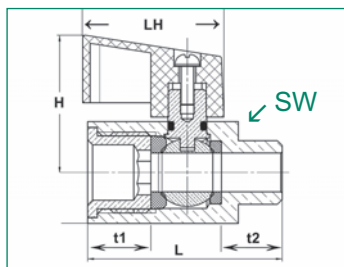

Like before, but F x M

Item-No.:	Conn.: F x M	Wrench size: SW	Ball-pas- sage:	Thread length:		Length:			Packing unit:
				t1	t2	L	H	LH	
53239 9	1/4"	21	8	9,5	9	40	28,3	-	25/150
53240 5	3/8"	21	8	10	9	40	28,3	-	25/150
53241 2	1/2"	25	10	11,5	12	45	30,1	-	20/120
53242 9	3/4"	30	14,5	13	15	54	32,6	-	14/ 70

Mini ball valve

F x M, nickel plated, long black plastic handle

Item-No.:	Connection:	Ball-passage:	Wre. size SW	Thread length:		Length:			Packing unit:
				t1	t2	L	H	LH	
53239-10880	1/4" f x m	8	21	9,5	10,5	41,5	33,5	73	16/128
S-2751	3/8" f x f	8	21	11	8	41,5	33,5	73	10/120

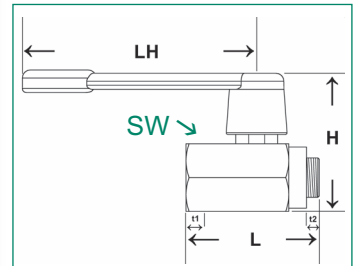

Chrome plated, long black T-handle (without illustration)

53229-10848-S	1/4" f x f	8	21	11	15	41,5	25,5	39	-/200
53230-10848-S	3/8" f x f	8	21	9,5	10,5	41,5	25,5	39	-/240
53239-10848-S	1/4" f x m	8	21	9,5	10,5	41,5	25,5	39	-/-

Spare parts:

53239-10880-Griff (handle)	Plastic, inclusive screw made of brass		-/100
53239-10880-PTFE-Dichtung	PTFE-Dichtungsring 5,5 mm		

ISO-Pump valve

Brass nickel plated, full flow, black plastic-T-handle, female thread/flange, PN 25

Item-No.:	Connection:	Ball-passage:	Thread length:	Length:				Pack. unit:
				t1	L	Ø	H	
53413 3	1" x 1" f/flange	24	15,5	88	44	75	83	8/48
53413-SK*	1" x 1" f/flange	24	15,5	87,5	42,5	76	83	8/48
53414 0	1 1/4" x 1" f/flange	24	14	90,5	44	75	83	8/48
53414-SK*	1 1/4" x 1" f/flange	24	15,5	87,5	42,5	76	83	8/48
53415 7	1 1/4" x 1 1/4" f/flange	32	18	101,5	57,5	84	83	2/20
53415-SK*	1 1/4" x 1 1/4" f/flange	31	15,5	111,5	55	86,5	100	2/20

*= with gravity brake

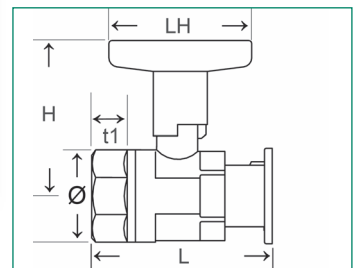

ISO-Pump valve

F x F, brass nickel plated, black plastic-T-handle, PN 25

Item-No.:	Conn.:	Ball-passage:	Thread length:	Length:				Packing unit:
				t1	L	Ø	H	
53400 3	3/8" F x F	10	9	40	23,5	52	83	-/-
53401 0	1/2" F x F	14,5	12,5	50	29	57	83	-/120
53402 7	3/4" F x F	19	12,5	55,5	36	59	83	-/ 60
53403 4	1" F x F	24	13	63	42,5	74	83	-/ 40
53404 1	1 1/4" F x F	32	15,5	77,5	55	80	83	-/-
53405 8	1 1/2" F x F	40	16,5	90	69	87	83	-/-
53406 5	2" F x F	50	19,5	109	84,5	95	83	-/-

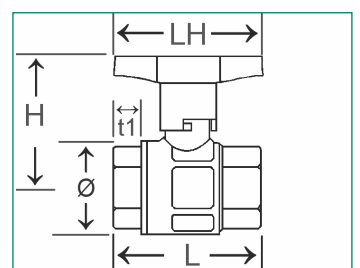

Thermometer for ISO-handle

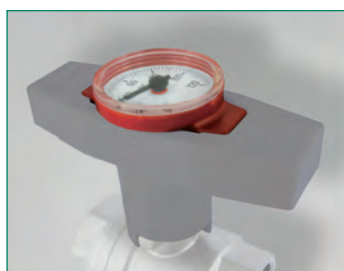

Plastic casing, 0 - 120°C, oval, red or blue

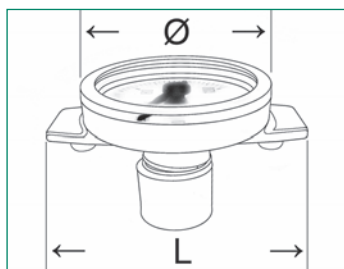

Item-No.:	Length:		Packing unit:
	L	Ø	
19134-R	55 mm	40 mm	20/200
19134-B	55 mm	40 mm	20/200

Ball valve with thermometer



F x F, with screw connection, thermometer Ø 41,5 mm, thermometer connection Ø 15 mm x 9 mm deep, range of temperature 0 - 60°C, metal casing

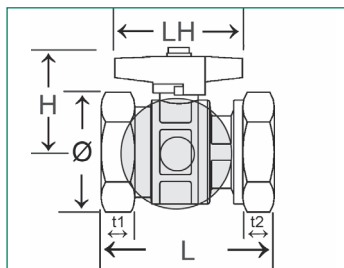

Item-No.:	Item-No.:	Con.:	Ball-pas-sage:	Thread length:		Length:				Packing unit:	
				t1	t2	L	Ø	H	LH		
nickel pla.	brass										
handle red or blue	handle red or blue										
S-3317-Ni-R	S-3317-bl-R	G1" x G1"	16	12,8	13	60	36	40	60	-/-	
S-3317-Ni-B	S-3317-bl-B	G1" x G1"	16	12,8	13	60	36	40	60	-/-	
Set consisting of 2 valves with thermometer, handle red and blue											
S-3317-Ni-R+B	S-3317-bl-R+B	G1" x G1"	16	12,8	13	60	36	40	60	2/ 18	
Spare part thermometer											
19121 4											20/240

Angle ball valve with thermometer



Nickel plated, short type, F x M, thermometer Ø 41,5 mm, thermometer connection Ø 15 mm x 9 mm deep, range of temperature 0 - 60°C, metal casing, wrench size 37

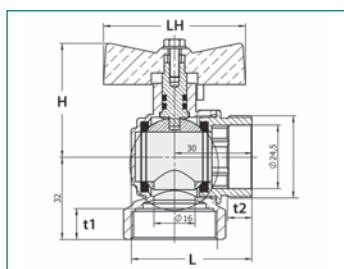

Item-No.:	Con.:	Ball-pas-sage:	Thread length:		Length:				Packing unit:	
			t1	t2	L	Ø	H	LH		
handle red or blue										
S-4004-MT (red)	G1" x G1"	16	12	9,5	47	24,5	44	55	-/48	
S-4004-b-MT (blue)	G1" x G1"	16	12	9,5	47	24,5	44	55	-/48	
Set consisting of 2 valves with thermometer, handle red and blue										
S-4004-MT-R+B	G1" x G1"	16	12	9,5	47	24,5	44	55	-/24	
Spare part thermometer										
19121 4										20/240

Pump ball valve with union

F x F x F, plain brass, with 2 threaded connections for thermometers, butterfly handle, PN 25

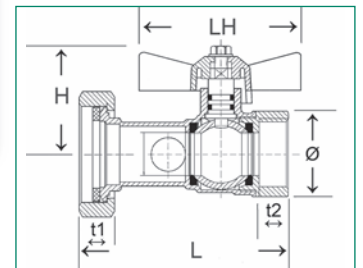

Item-No.:	Connection:	Ball-pas-sage:	Thread length:		Length:				Packing unit:
			t1	t2	L	Ø	H	LH	
S-2511	G 1 1/2" x 1", 2 x G 1/2"	20	13,5	14	98	40	47	62	4/ 24
S-2511-SKB*	G 1 1/2" x 1", 2 x G 1/2"	19	13,5	14	98	40	47	62	-/-
Spare part gravity brake for union nut G 1 1/2"									
S-2512-SKB	M 30 x 1,5 mm x 14 mm	19							-/600

*= with gravity brake

Pump ball valve with union

Plain brass, with red T-handle

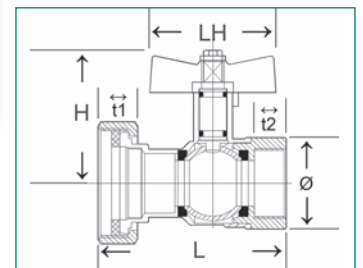

Item-No.:	Connection:	Ball-pas-sage:	Thread length:		Length:				Pack. unit:
			t1	t2	L	Ø	H	LH	
S-2520	G 1 1/2" x 1"	22	14	18	88	46	68	62	-/48
S-2520-SKB*	G 1 1/2" x 1"	19	14	18	88	46	68	62	-/-
S-3302	G 2" x 1 1/4"	22	13,5	18	102		65	85	-/-
S-3302-SKB*	G 2" x 1 1/4"	22	13,5	18	102		65	85	-/-

*= with gravity brake

Gravity brake

For ball valves with union and ISO-T

Item-No.:	suitable for item-no.:	Ballpassage:	with thread:	Pack. unit:
S-2512	S-2520	19	M 30 x 1,5 mm	100/500
	53413-SK			
	53414-SK			



Item-No.:	suitable for item-no.:	Ballpassage:	with snap ring:	Pack. unit:
83824 8	S-3302		Ø 32 mm	-/50
	53415-SK			



Pump flange multi-tap

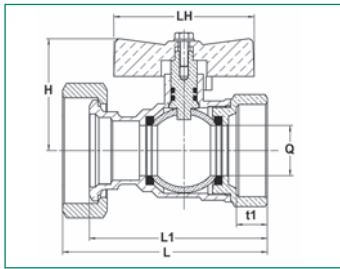

Plain brass, with red T-handle, union nut x female thread

Item-No.:	Connection:	Ball-passage:	Thread length:		Length:				Pack. unit:
			t1	L	L1	Ø	H	LH	
	Union nut X F		t1	L	L1	Ø	H	LH	
S-4264	G 1 1/2" x G 1 1/4"		13,5	90	78	22	49	61,5	
S-4265	G 2" x G 2"		18	110	97	37	64	75	
S-4316	G 2" x 1 1/2"		18	110	97	37	64	75	

Pump flange multi-tap

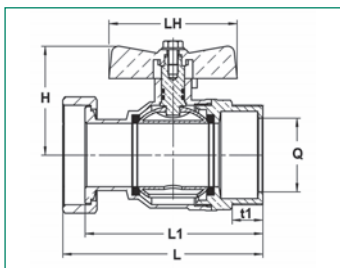

Plain brass, with red T-handle, F x M

Item-No.:	Connection:	Ball-passage:	Thread length:		Length:				Pack. unit:
			t1	L	L1	Ø	H	LH	
	F X M		t1	L	L1	Ø	H	LH	
S-4266	G 2" x G 2"		18	117	104	37	64	75	

Pump valve with union nut

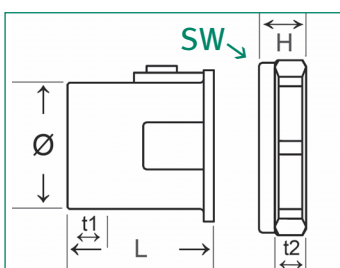

Plain brass, 1" female thread, including nut

Item-No.:	Connection:	Ball-passage:	Thread length:		Length:			Wrench size:	Packing unit:
			t1	t2	L	Ø	H		
			t1	t2	L	Ø	H	SW	
S-68	1" x 1 1/2"	18,5	12,5	9	43,5	37,5	14	52	4/60

Ball valve

Plain brass, union nut X M, short design

Item-No.:	Connection:	Ball-pas-sage:	Thread length:		Length:				Pack. unit:
			t1	t2	L	L1	Ø	H	
S-4267	G1 1/2" x G1 1/2"	19	22		58,5	50	32		52

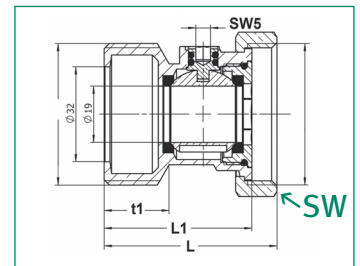

Pump ball valve with compression connector

Plain brass, including union nut

Item-No.:	Connection:	Ball-pas-sage:	Thread length:		Length:		Wrench size:	Packing unit:
			t1	t2	L	H		
S-32	28 mm x G1 1/2"	18,5	12	9	58,5	14	52	6/60

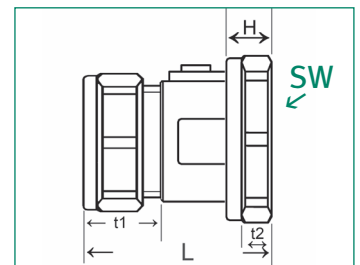

Pump ball valve

Brass nickel plated, 1" female thread, including union nut 1 1/2", heavy version

Item-No.:	Connection:	Ball-pas-sage:	Thread length:		Length:		Wrench size:	Packing unit:
			t1	t2	L	H		
S-42	G1" x G1 1/2"	19	15	16	50	19	52	-/72

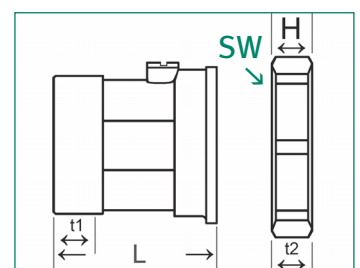

Union nut

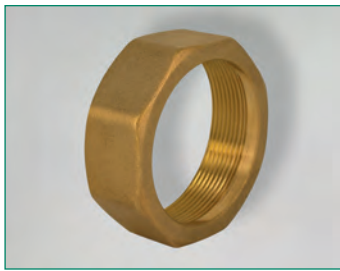

Plain brass, female threaded (matches to S-68)

Item-No.:	Connection:	Thread length:	Height:	Wrench size:	Packing unit:
		t1	H	SW	
S-69	M47 x 1,5	15,5	19	52	25/300

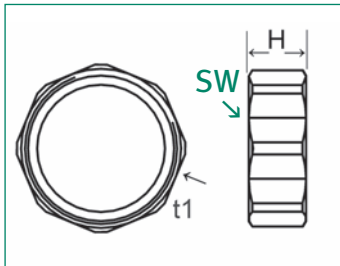

Screw connection for ball valves



M x F, brass nickel plated, flat sealing

Item-No.:	Connec.:	Thread length:		Length:		Wrench size:	Packing unit:
		t1	t2	L	H		
	M x F					SW	
S-107	3/4" x 1"	11	13	35	13	37	1/220

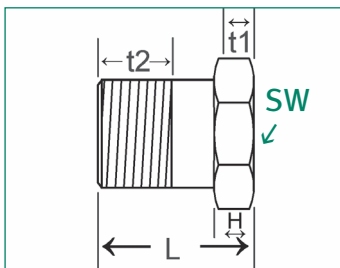

Ball valve



Plain brass, hose connectors on both sides, red steel lever

Item-No.:	Conn.:	Ball-passage:	Spout length:	Length:			LH	Pack. unit:
				TL	L	Inside Ø		
S-029		12	30	92	12	17	75,5	10/80
S-3192		14,5	39	110,5	14,5	20	75,5	-/60
S-030		21	30	102	21	25,4	120	6/36

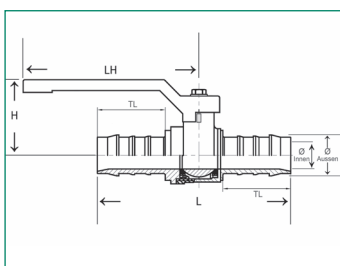

Fill and drain valve

Plain brass, with stuffing box, loop with cap, temperature range up to max. + 90°C, seals conical

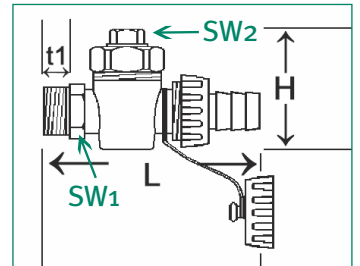
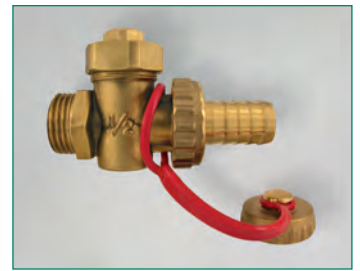

Item-No.:	Conn.:	Ball-passage:	Thread length: t1	Length:		Wrench size:		PN:	Packing unit:
				L	H	SW1	SW2		
54711 9	1/2"	9	8,5	72,5	47,5	22	12	10	10/100
54712 6	3/4"	-	11,5	92,3	55	28	14	-	10/ 60

Fill and drain ball valve

Complete with cap, chain and hose connector, O-ring made of FKM, red butterfly handle, self sealing, with locking ring, temperature range up to max. + 110° C

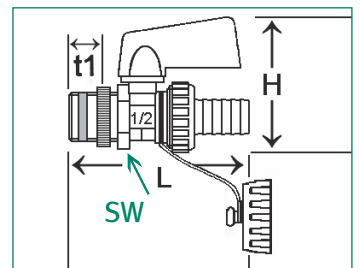

Item-No.:	Item-No.:	Conn.:	Ball-passage:	Thread length: t1	Length:		Wrench size: SW	PN:	Packing unit:
plain	nickel plat.				L	H			
54731 7	54736 2	1/2"	9	21	77,5	49	24	10	10/100

Fill and drain ball valve

Heavy version, nickel plated, complete with cap, chain and hose connector, O-ring made of FKM, red butterfly handle, self sealing, with locking ring, temperature range up to max. + 110° C

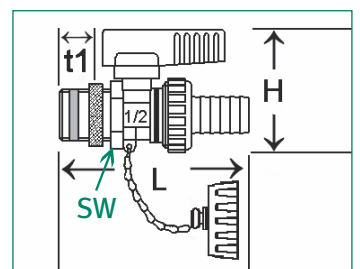

Item-No.:	Item-No.:	Conn.:	Ball-passage:	Thread length: t1	Length:		Wrench size: SW	PN:	Packing unit:
plain	nickel plat.				L	H			
-	54738 6	1/2"	9	21	77,5	49	24	10	15/90

Fill and drain ball valve



Complete with cap, chain, hose connector, not self-sealing, O-ring made of FKM, red aluminium butterfly handle

Item-No.:	Item-No.:	Conn.:	Ball-pas- sage:	Thread length:	Length:		Wrench size:	PN:	Packing unit:
					L	H			
plain	nick. plat.			t ₁			SW		
54741 6	54746 1	1/2"	9	16	72,5	52	24	10	12/144
54742 6	54747 8	3/4"	9	16	70,5	52	24		10/100

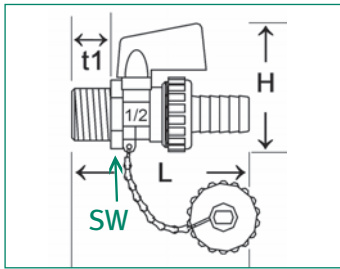

Fill and drain ball valve, PN 10

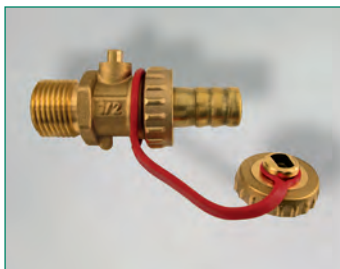

Plain brass, complete with cap, plastic loop and hose connector, O-ring made of FKM, temperature range up to max. + 110° C

Item-No.:	Conn.:	Ball- passage:	Thread length:	Length:		Wrench size:	PN:	Packing unit:
				L	H			
			t ₁			SW		
54720 1	3/8"							12/144
54721 8	1/2"	9	16	72,5	35,5	24	10	15/ 90

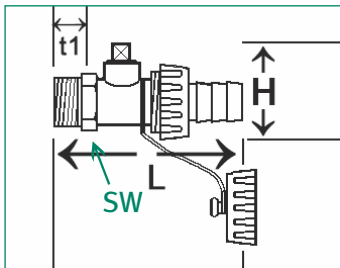

Fill and drain valve



Compact design, with cap and plastic loop, hose connector, self sealing

Item-No.:	Connection:	Thread length:	Length:	Wrench size:	PN:	Packing unit:
54744-ver2	1/2" x M 21 x 1,5 mm	4	66,5	24	10	12/144

Spare part for 54744 (without illustration)

Item-No.:	Connection:
54744-Verschraubung	1/2" x M 21 x 1,5 mm

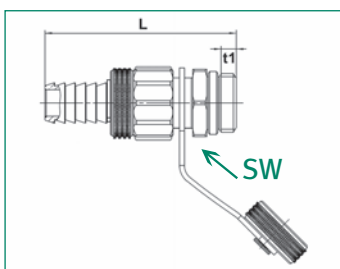

Fill and drain valve

Set of 2 union nuts made of plain brass or nickel-plated, with ventilation screw, red and blue handle, with removable nut

Item-No.:	Item-No.:	Connection:	Ball-pas-sage:	Thread length:	Length:		Wr. size:	Pack. unit:
					L	H		
plain brass	nickel-plated	F x M		t1			SW	
S-2678	S-2678-Ni	G1" x 3/4"	8	7	66	67,5	37	-/40

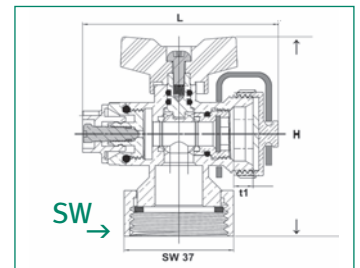

Replacement loop with cap

Black plastic loop with blank brass cap and sealing

Item-No.:	Conn.:	Thread length:	Length:				Packing unit:
			L loop	Ø loop	Ø cap	H	
S-2606-bl	3/4"	t1	84	24	29	14,5	1/1100

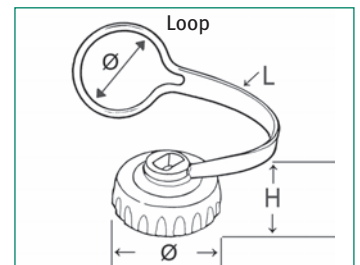

Radiator valve with turnable outlet

Brass, heavy version, swivel spout, with connection option for 3/4" hose connectors, captive cap with EPDM sealing

Item-No.:	Item-No.:	Conn.:	Leav.:	Thread length:	Length:		Wr. size:	PN:	Packing unit:
					L	H			
plain	nickel plated			t1			SW		
S-346-1/2	S-346-1/2-Ni	1/2"	3/4"	5	47	45	24	10	12/100
S-346-3/8	S-346-3/8-Ni	3/8"	3/4"	5	47	45	24	10	12/100
S-1947		1/2"	1/2"						12/100
Spare part for S-346-1/2/Ni:									
S-346-O-Ring		7,2 x 1,9 mm							

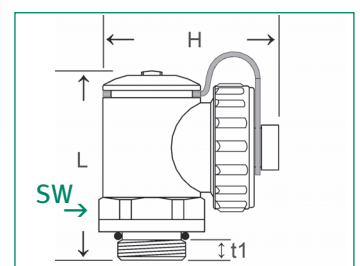

Radiator valve with turnable outlet



Brass, light version, swivel spout

Item-No.:	Item-No.:	Connec.:	Thread length: t1	Length:		Wr. size: SW	PN:	Packing unit:
				L	H			
plain	nickel plated							
S-1776-3/8	S-1776-3/8-Ni	3/8"	8	49	44	24		-/120
S-1776-1/2	S-1776-1/2-Ni	1/2"	8	49	44	24		-/120
S-1776-1	S-1776-1-Ni	1"	9,5	56	52	27		-/ 80

as above, only cap male thread x female thread 3/4" NPT

-	S-1776-1-Ni-NPT	1" x 3/4"	7	61	53	27		-/-
---	-----------------	-----------	---	----	----	----	--	-----

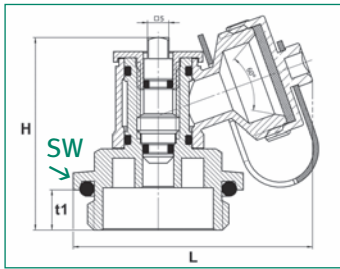

Heater fork piece



Brass nickel-plated, with Euro-cone

Item-No.:	Connec.:	Thread length: t1 M	Length: L	Wrench size: SW	Packing unit:
36299 6	G3/4" x G3/4" x G3/4"	8	50	30	-/100

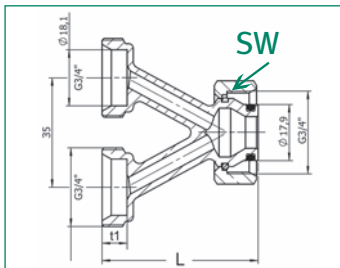

Connection nipple



M x F, brass, with O-ring in groove

Item-No.:	Item-No.:	Conn.:	Thread length: t1	Length:		Wrench size: SW	Packing unit:
				Ø			
plain	nickel plated						
S-731-Nippel	S-731-Nippel-Ni	1" x 1/2"	6	39	19,5	27	10/350

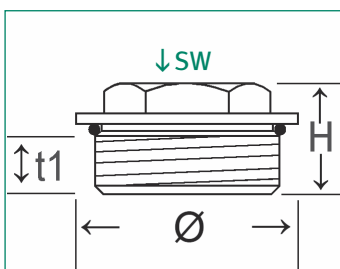

Reducing nipple

Brass nickel plated, sandblasted, with O-ring in groove

Item-No.:	Thread:		Length: L	Wrench size: SW	Packing unit:
	t1 F	t2 M			
S-3082-4	3/4"	1"	18	32	-/300
Spare part:					
S-3082-4-O-Ring	30 x 3,5 mm				

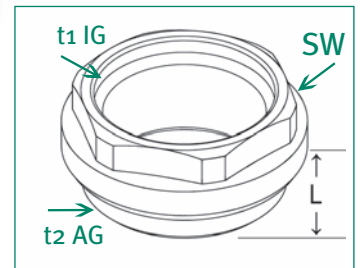
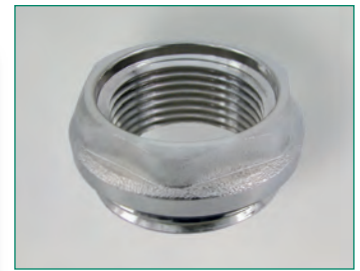

Reducing nipple

Plain brass, with O-ring, not routed

Item-No.:	Thread:		Length: L	Wrench size: SW	Packing unit:
	t1 F	t2 M			
S-730-3/4	3/4"	1"	19	30	-/-

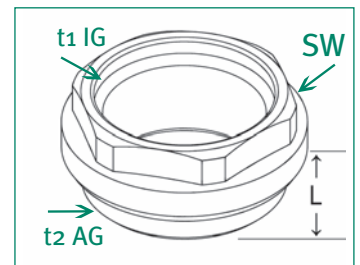

Mounting kit for manifolds



Consisting of 8 parts, 2 ball valves with screw connections (red/blue), 2 fill and drain valves, 2 T-pieces made of brass with turnable screw connection at the top, 2 airvent plugs

Qua.:	Item-No.:	Description:
	54791 1	
Set consisting of:		
1	53373 0	Ball valve, brass, red lever f G1" x m G1"
1	53373-Blau	Ball valve, brass, blue lever f G1" x m G1"
2	S-346-1/2-Ni	Fill and drain valve 1/2" x 3/4"
2	S-822-Ni	T-piece, brass f G1/2" x m G1" x f G1/2"
2	54761 4	Air vent plugs 1/2"

Mounting kit for manifolds



Consisting of 10 parts, 2 ball valves with screw connections (red/blue), 2 fill and drain valves, 2 T-pieces made of brass with turnable screw connection at the top, 2 airvent plugs, 2 plugs with O-ring

Qua.:	Item-No.:	Description:
	54792 8	
Set consisting of:		
1	53373 0	Ball valve, brass, red lever f G1" x m G1"
1	53373-Blau	Ball valve, brass, blue lever f G1" x m G1"
2	S-346-1/2-Ni	Fill and drain valve 1/2" x 3/4"
2	S-822-Ni	T-piece, brass f G1/2" x m G1" x f G1/2"
2	54761 4	Air vent plugs 1/2"
2	54760 7	Closure plugs G1/2"

Ball valves for manifold connection



Set of 2 ball valves, nickel plated, with self-sealing screw connection with fixed O-ring (FKM), T-handle red and T-handle blue

Item-No.:	Ball-pas-sage:	Thread length:		Length:	Heigth:	Pack. unit:
		F G1"	M G1"			
Brass*				L	H	
53373-11658-R+B	24,4	11	8	84	45	-/16

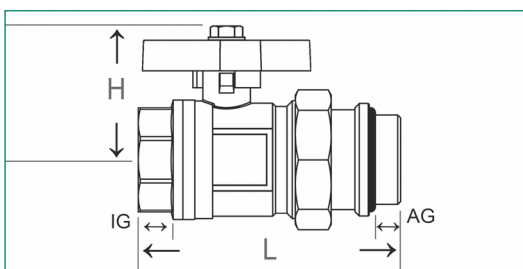

Mounting kit for manifolds „S-3087“

Brass*, 90°, 1" male thread x 1" female thread, consisting of:

Qua.:	Item-No.:	Description:
1	53373-11658	Ball valve, brass, red lever G 1" x G 1"
1	53373-11658-B	Ball valve, brass, blue lever G 1" x G 1"
2	S-3087-1	T-piece, with turnable top screw connection F G 1" x M G 1" x F G 1/2"
2	54760-11555	Plug with O-ring G 1/2"

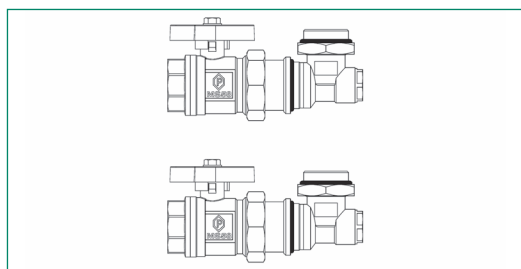

Brass*, for heat meter mounting kits 1/2", full flow, length = 110 mm, consisting of:

Qua.:	Item-No.:	Description:
1	S-3082-2	3/4" glassfibre reinforced PA tube, black, 110 mm
1	S-3082-1	Screw connection, brass F G 3/4" x M 3/4"
2	S-3082-4	Reducing nipple, brass, O-ring F G 3/4" x M G 1"
1	S-3082-3	Screw connection, brass F G 1" x F G 3/4"
2	53372-Versch.	Screw connection for ball valve G 3/4" x G 1"
1	S-3082-5-R	Ball valve, brass, with sensor connection, red handle G 3/4" x G 1" x M10 x 1 mm
1	S-3082-5-B	Ball valve, brass, with sensor connection, blue handle G 3/4" x G 1" x M10 x 1 mm
1	53288-blau	Ball valve, brass, blue handle F G 3/4" x M G 1" L=50

Heat meter mounting kit „S-3082“

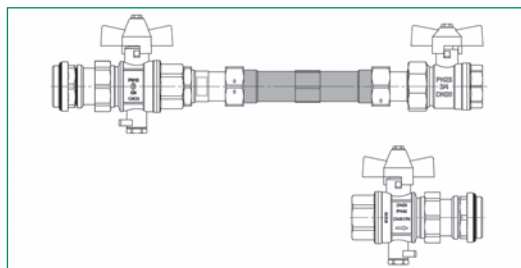

* Brass parts are made of CW 617 N, nickel plated

Brass*, for heat meter mounting kits 1/2", 90°, length = 110 mm, consisting of:

Qua.:	Item-No.:	Description:
1	S-3082-2	3/4" glassfibre reinforced PA tube, black, 110 mm
1	S-3082-3	Screw connection, brass F G 1" x F G 3/4"
1	S-3083-1	T-piece, brass F G 3/4" x M G 1" x F G 1/2"
1	S-3083-2	T-piece, brass F G 3/4" x M 3/4" x F G 1/2"
1	S-3082-4	Reducing nipple, brass, O-ring F G 3/4" x M G 1"
1	54760-11555	Plug with O-ring G 1/2"
1	54761 4	Airvent plug 1/2"
2	53372-Versch.	Screw connection for ball valve G 3/4" x G 1"
1	S-3082-5-R	Ball valve, brass, with sensor connection, red handle G 3/4" x G 1" x M10 x 1 mm
1	S-3082-5-B	Ball valve, brass, with sensor connection, blue handle G 3/4" x G 1" x M10 x 1 mm
1	53288-blau	Ball valve, brass, blue handle F G 3/4" x M G 1" L=50

Heat meter mounting kit „S-3083“

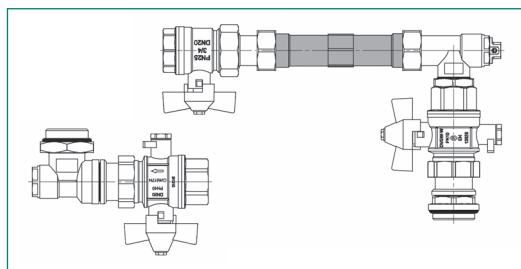
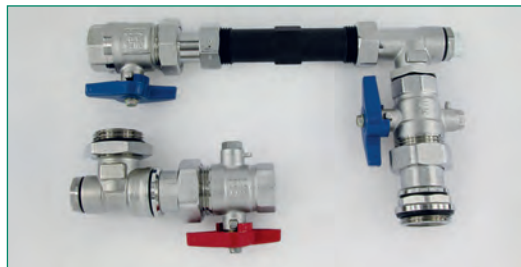

Heat meter mounting kit „S-3084“

Brass*, for heat meter mounting kits 3/4", full flow, length = 130 mm, consisting of:

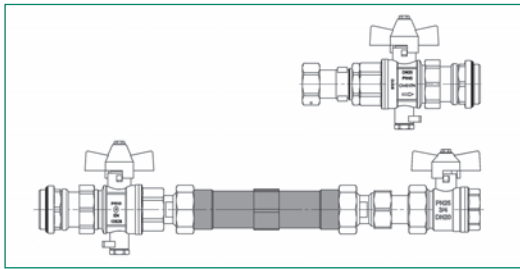

Qua.:	Item-No.:	Description:
1	S-3084-2	1" glassfibre reinforced PA tube, black, 130 mm
1	S-3082-1	Screw connection, brass F G 3/4" x M 3/4"
1	S-3082-3	Screw connection, brass F G 1" x F G 3/4"
2	S-3082-4	Reducing nipple, brass, O-ring F G 3/4" x M G 1"
2	S-3084-1	Screw connection, brass M G 3/4" x F 1"
2	53372-Versch.	Screw connection for ball valve G 3/4" x G 1"
1	S-3082-5-R	Ball valve, brass, with sensor connection, red handle G 3/4" x G 1" x M10 x 1 mm
1	S-3082-5-B	Ball valve, brass, with sensor connection, blue handle G 3/4" x G 1" x M10 x 1 mm
1	53288-blau	Ball valve, brass, blue handle F G 3/4" x M G 1" L=50

Heat meter mounting kit „S-3085“

Brass*, for heat meter mounting kits 3/4", 90°, length = 130 mm, consisting of:

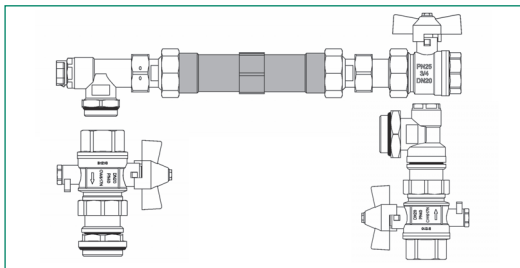

Qua.:	Item-No.:	Description:
1	S-3084-2	1" glassfibre reinforced PA tube, black, 130 mm
2	S-3084-1	Screw connection, brass M G 3/4" x F 1"
1	S-3083-1	T-piece, brass F G 3/4" x M G 1" x F G 1/2"
1	S-3083-2	T-piece, brass F G 3/4" x M 3/4" x F G 1/2"
1	S-3082-3	Screw connection, brass F G 1" x F G 3/4"
1	S-3082-4	Reducing nipple, brass, O-ring F G 3/4" x M G 1"
1	54760-11555	Plug with O-ring G 1/2"
1	54761	Airvent plug 1/2"
2	53372-Versch.	Screw connection for ball valve G 3/4" x G 1"
1	S-3082-5-R	Ball valve, brass, with sensor connection, red handle G 3/4" x G 1" x M10 x 1 mm
1	S-3082-5-B	Ball valve, brass, with sensor connection, blue handle G 3/4" x G 1" x M10 x 1 mm
1	53288-blau	Ball valve, brass, blue handle F G 3/4" x M G 1" L=50

Detailed description in particular:

S-3082-1	Screw connection, brass	look page 67
S-3082-2	3/4" glassfibre reinforced PA tube, black	look page 72
S-3082-3	Screw connection, brass	look page 68
S-3082-4	Reducing nipple, brass	look page 68

S-3082-5-R	Ball valve, brass, with sensor connection, red handle	look page 33
S-3082-5-B	Ball valve, brass, with sensor connection, blue handle	look page 33
S-3083-1	T-piece, brass	look page 67
S-3083-2	T-piece, brass	look page 67

Heat meter mounting kit-40160-1

Heat meter mounting kit horizontal

Pos.:	Qua.:	Item-No.:	Description:
1	1	S-3818-02-b	Ball valve, brass, nickel-plated, blue, reduced, with union nut, F/F, G1" x G1"
2	2	S-3938-OD	Reducing nipple, brass, nickel-plated, flat sealing, without seal, M/F, G1" x G3/4"
3	1	S-3082-2	Connecting tube, black, M/M, G3/4" x 110 mm
4	1	S-3969-01-b	Ball valve, brass, nickel-plated, blue, 2 union nut, sensor connection, F/F, G1" x G1" x M10 x 1 mm
5	1	S-3818-03	Ball valve, brass, nickel-plated, red, union nut, sensor connection, F/F, G1" x G1" x M10 x 1 mm
6	4	49011	Seal ring, 1/2", 30 mm x 21 mm x 2 mm
7	2	WS-551-AFM	Sealing AFM, KTW audited, 16,9 mm x 23,7 mm x 2 mm (3/4")

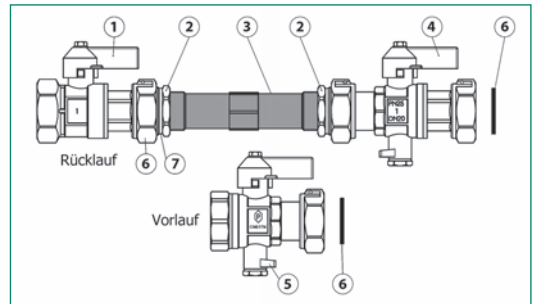
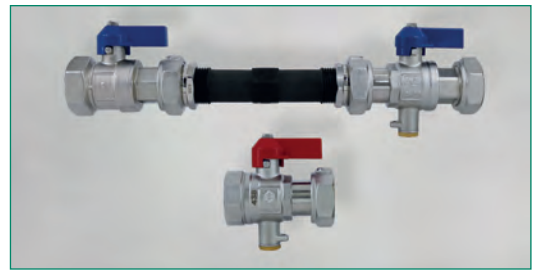

Heat meter mounting kit vertical

Pos.:	Qua.:	Item-No.:	Description:
1	1	S-3818-02-b	Ball valve, brass, nickel-plated, blue, reduced, with union nut, F/F, G1" x G1"
2	2	S-3938-OD	Reducing nipple, brass, nickel-plated, flat sealing, without seal, M/F, G1" x G3/4"
3	1	S-3082-2	Connecting tube, black, M/M, G3/4" x 110 mm
4	1	S-3818-04	Angle, brass, F/M, with 2 union nut, 90°, G1" x G1" x 35 mm x 65 mm
5	1	S-3969-01-b	Ball valve, brass, nickel-plated, blue, 2 union nut, sensor connection, F/F, G1" x G1" x M10 x 1 mm
6	1	S-3818-03	Ball valve, brass, nickel-plated, red, union nut, sensor connection, F/F, G1" x G1" x M10 x 1 mm
7	1	S-3037-Ni	Angle, brass, nickel-plated, M/F, with union nut, 90°, G1" x G1"
8	6	49011	Seal ring, 1/2", 30 mm x 21 mm x 2 mm
9	2	WS-551-AFM	Sealing AFM, KTW audited, 16,9 mm x 23,7 mm x 2 mm (3/4")

Heat meter mounting kit-40160-2

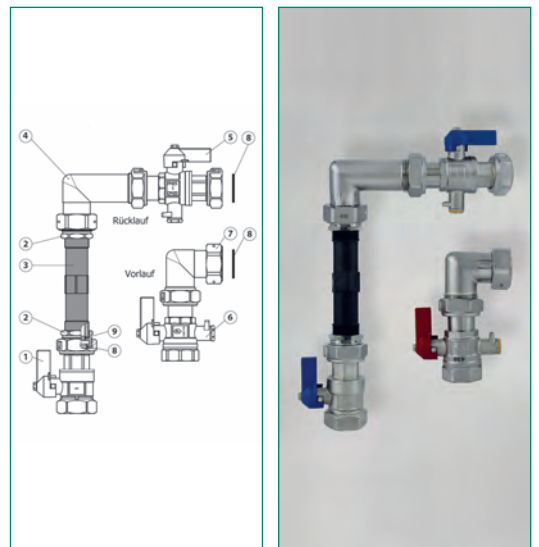

Angle-ball valve-set

Pos.:	Qua.:	Item-No.:	Description:
1	1	S-3816	Ball valve, brass, nickel-plated, red, union nut, angular shape 120 mm, F/F, G1" x G1" x DN19 x 120 mm
2	1	S-3817-b	Ball valve, brass, nickel-plated, blue, screw, angular shape 42 mm, F/F, G1" x G1" x DN19 x 42 mm
3	2	49011	Seal ring, 1/2", 30 mm x 21 mm x 2 mm

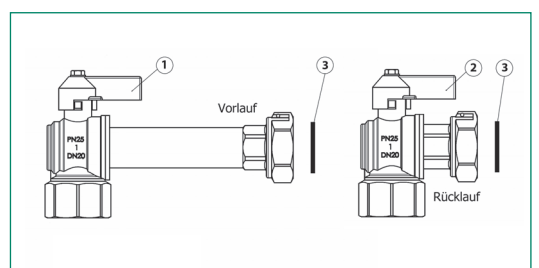
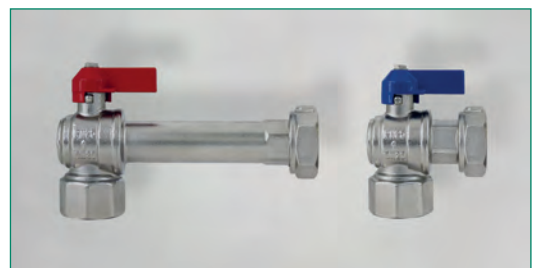

All components are pre-assembled, sealings of individual components using O-rings or flat sealings

Cap valve

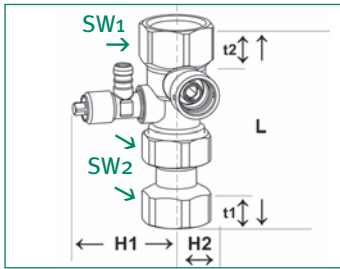

Completely plain brass, including drain valve, plastic cap, sealing wire and lead seal, suitable for solar applications as well

Item-No.:	Conn.:	Thread length:		Length:			Wrench size:		PN:	Packing unit:
		t1	t2	L	H1	H2	SW1	SW2		
plain										
S-2313-3/4	3/4"	13	17	94	50	37	30	30	10	-/ 36
S-2313-1	1"	15,5	15	99	50	37	37	37	10	-/ 36

Spare parts for cap valve:

S-2312-1-2	Sealing wire + lead seal									/1000
S-2312-3	Plastic cap									10/1000
S 2312-1"-AFM	Replacement seal, AFM 34, KTW-tested, 30 x 20 x 2 mm (1")									/5000

Bourdon tube pressure gauge

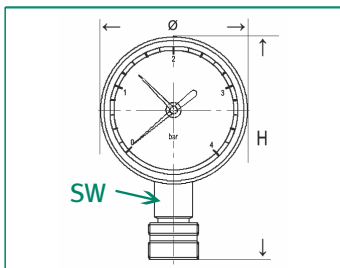

Plastic housing, self sealing, 0-4 bar, NG 63

Item-No.:	Dim.:	Ø	Hight H:	Wrench size:	Pack. unit:
19140 4	G3/8"	62	84,4	14	-/-

Union made of brass

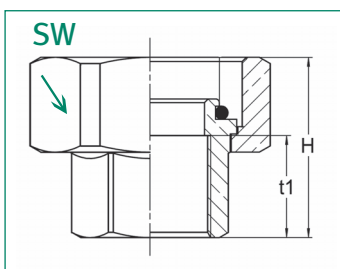
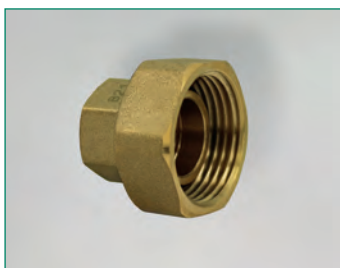

Plain brass, F x union nut, with O-ring sealing

Item-No.:	Dim.:	Thread length:	Length:	Wrench size:	Packing unit:
		t1	H		
34695 8	G3/8" conn., G3/4" union nut	14	25	30	20/240

Radiator valve*, straight type

Brass, can be isolated and regulated, temperature range up to max. + 110° C, double-sided flow direction, spindle with O-ring seal, to be shut-off with hexagon socket (wrench size 8)

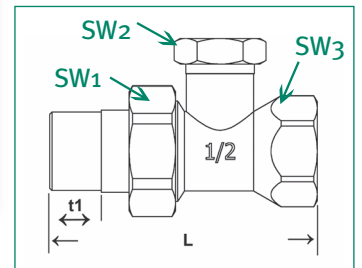

Item-No.:	Item-No.:	Conn.:	Thread length:	Length:		Wrench size:	PN:	Packing unit:
				t1	L			
plain	nickel pla.		t1	L	H	SW 1/2/3		
54610 5	54615 0	3/8"	10	63	36		10	12/108
54611 2	54616 7	1/2"	11	68,5	39	27/20/20	10	12/ 96
54612 9	54617 4	3/4"	13	80,5	41	38/26/32	10	8/ 80
54613 6	54618 1	1"		99			10	-/ 60
Spare part EPDM O-Ring for parking screw:								
54614 3	for 3/8" + 1/2"							

Radiator valve*, angular type

Brass, can be isolated and regulated, temperature range up to max. + 110° C, double-sided flow direction, spindle with O-ring seal, to be shut-off with hexagon socket (wrench size 8)

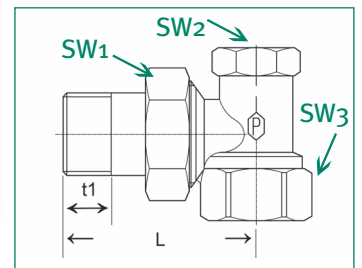

Item-No.:	Item-No.:	Conn.:	Thread length:		Length:		Wrench size:	PN:	Packing unit:
			t1	t2	L	H			
plain	nickel pla.		t1	t2	L	H	SW 1/2/3		
54620 4	54625 9	3/8"	11	8,5		45		10	12/108
54621 1	54626 6	1/2"	11,5	10	48	45	27/20/20	10	12/ 96
54622 8	54627 3	3/4"	12,5	11	59	49	38/26/32	10	8/ 80
54623 5	54628 0	1"			67			10	-/ 80
Spare part EPDM O-Ring for parking screw:									
54614 3	for 3/8" + 1/2"								

Radiator valve* with solder connection, straight type

Brass, can be isolated and regulated, temperature range up to max. + 110° C

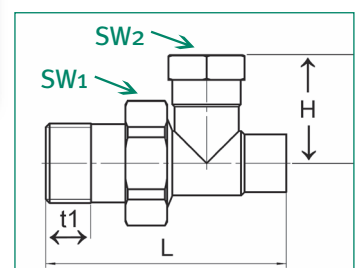

Item-No.:	Item-No.:	Connection:	Thread length:	Length:		Wrench size:	PN:	Packing unit:
				L	H			
plain	nickel pla.		t1	L	H	1/2		
54630 3	54635 8	3/8" x 12 mm		62			10	12/144
54631 0	54636 5	1/2" x 12 mm	12	63,5	26	30/20	10	12/144
54632 7	54637 2	1/2" x 15 mm	11,5	65,5	26	30/27	10	12/ 96
Spare part EPDM O-Ring for parking screw:								
54614 3	for 3/8" + 1/2"							

Radiator valve* with solder connection, angular type



Brass, can be isolated and regulated, temperature range up to max. + 110° C

Item-No.:	Item-No.:	Connection:	Thread length:		Length:		Wrench size:	PN:	Packing unit:
			t1		L	H			
plain	nickel pla.						SW 1/2		
54640 2	54645 7	3/8" x 12 mm				45		10	12/144
54641 9	54646 4	1/2" x 12 mm	12		43,5	46,5	30/20	10	12/144
54642 6	54647 1	1/2" x 15 mm	12,5		45	48	30/20	10	12/108

Spare part EPDM O-Ring for parking screw:

54614 3	for 3/8" + 1/2"								
---------	-----------------	--	--	--	--	--	--	--	--

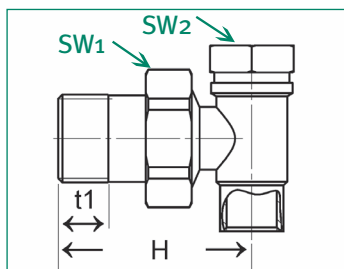

* Note: radiator fittings are only for tension-free mounting

Two-pipe valve block, straight type



Brass nickel plated, 50 mm distance, ball shut-off, self-sealing connection nipple (O-ring), hexagon nut with tolerance compensation, non-slipping sealing insert, operating temperature max. 120° C, packed in single box

Item-No.:	Execution:	Conn.:	Thread length:		Length:		Wre. size:	PN:	Packing unit:
			t1	t2	L	H			
54511 5	with connection nipple	1/2"			50	67	30	10	1/40
54512 2	with Euro conus	3/4"			50	56	30	10	1/42

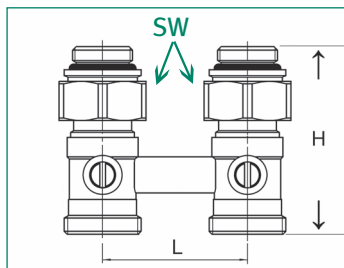

Two-pipe valve block, angular type



Brass nickel plated, 50 mm distance, self-sealing connection nipple (O-ring), hexagon nut with tolerance compensation, non-slipping sealing insert, operating temperature max. 120° C, packed in single box

Item-No.:	Execution:	Conn.:	Thread length:	Length:			Wre. size:	PN:	Pack. unit:
				t1	L1	L2			
54521 4	with connection nipple	1/2"		50		55	30	10	1/40
54522 1	with Euro conus	3/4"		50		45	30	10	1/42

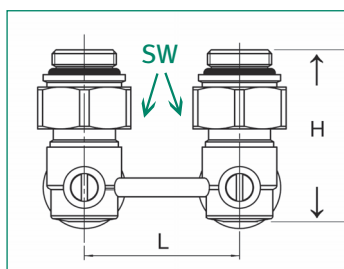

Single-pipe valve block, straight type

Brass nickel plated, self-sealing connection nipple (O-ring), hexagon nut with tolerance compensation, non-slipping sealing insert, operating temperature max. 120° C, packed in single box

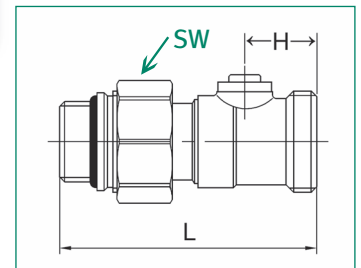

Item-No.:	Execution:	Conn.:	Thread length:		Length:			Wre. size:	PN:	Packing unit:
			t1	t2	L	H	SW			
54516 0	with connection nipple	1/2"			67	36	30	10	1/125	
54517 7	with Euro conus	3/4"			56	36	30	10	1/175	

Single-pipe valve block, angular type

Brass nickel plated, self-sealing connection nipple (O-ring), hexagon nut with tolerance compensation, non-slipping sealing insert, operating temperature max. 120° C, packed in single box

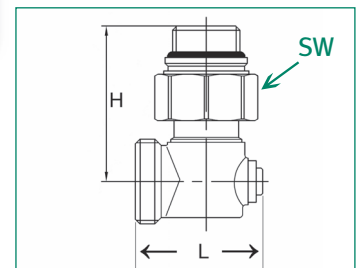

Item-No.:	Execution:	Conn.:	Thread length:		Length:			Wre. size:	PN:	Packing unit:
			t1	t2	L	H	SW			
54526 9	with connection nipple	1/2"			46	61	30	10	1/125	
54527 6	with Euro conus	3/4"			47	47	30	10	1/175	

Single-pipe valve block, straight type

Brass nickel plated, with gravity brake, packed in single box

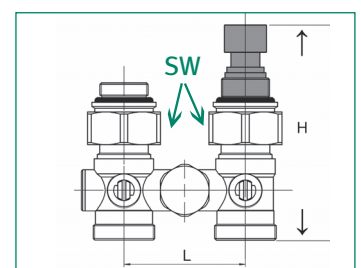

Item-No.:	Execution:	Conn.:	Thread length:		Length:			Wre. size:	PN:	Pack. unit:
			t1	t2	L1	L2	H			
54531 3	with connection nipple	1/2"			50		89	30	10	1/60
54532 0	with Euro conus	3/4"			50		55	30	10	1/60

Single-pipe valve block, angular type



Brass nickel plated, with gravity brake, packed in single box

Item-No.:	Execution: Center distance 50 mm	Conn.:	Thread length:		Length:			Wre. size: SW	PN:	Pack. unit:
			t1	t2	L1	L2	H			
54541 6	with connection nipple	1/2"			50		89	30	10	1/60
54542 9	with Euro conus	3/4"			50		55	30	10	1/60

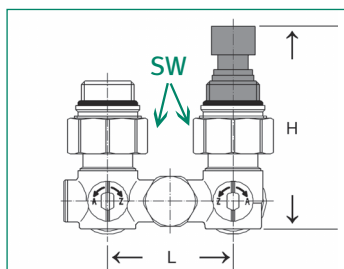

Spare parts for valve blocks without illustration

Item-No.:	Spare part:	Connection:	P. unit:
54518 4	Connection nipple made of brass	1/2" x 3/4"	-/-
54519 1	Euro conus for valve blocks made of brass	3/4"	-/-
54528 3	EPDM-moulded seal		-/-

Compression fitting for aluminium composite piping - and plastic pipes

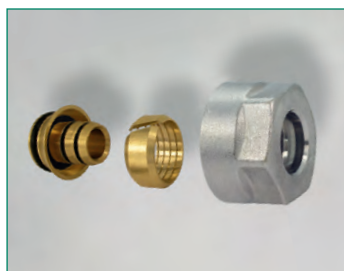

Consisting of: 2 compression fittings 2-pieces, brass, 3/4" female thread, with round nut, packaged as 2 pcs-set

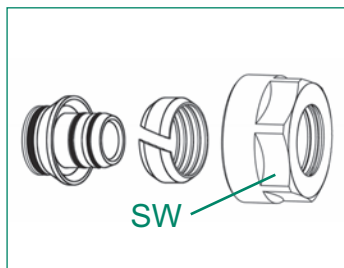

Item-No.:	Item-No.:	Dimension:	Wrench size:	Packing unit:
nickel plated	plain		SW:	
36210 1	36220 0	10 x 2 mm	27	-/-
36211 8	36221 7	12 x 1,8 mm	27	-/-
36212 5	36222 4	14 x 2 mm	27	-/-
36214 9	36224 8	16 x 2 mm	27	-/-
36215 6	36225 5	17 x 2 mm	27	-/-
36216 3	36226 2	18 x 2 mm	27	-/-
36217 0	36227 9	20 x 2 mm	27	-/-
for PEX-pipe, without corrosion protection and O-rings				
36218 7	36228 6	20 x 3,4 mm	27	-/-

Compression fitting for aluminium composite piping - and plastic pipes



Consisting of: 2 compression fittings 3-pieces, brass, 3/4" female thread, packaged as 2 pcs-set

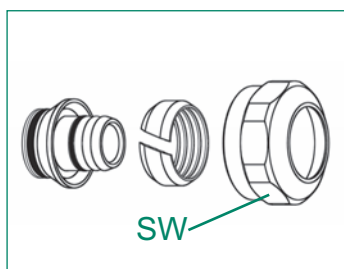

Item-No.:	Item-No.:	Dimension:	Wrench size:	Packing unit:
nickel plated	plain		SW:	
36230 9	36240 8	10 x 2 mm	30	-/-
36231 6	36241 5	12 x 2 mm	30	-/-
36232 3	36242 2	14 x 2 mm	30	-/100
36234 7	36244 6	16 x 2 mm	30	-/100
36235 4	36245 3	17 x 2 mm	30	-/100
36236 1	36246 0	18 x 2 mm	30	-/100
36237 8	36247 7	20 x 2 mm	30	-/100

Connection fitting for aluminium composite piping - and plastic pipes

Consisting of: compression fitting 3-pieces, with reducing nipple (G1/2" x G3/4" Euro cone), brass nickel plated or brass

Item-No.:	Item-No.:	Dimension:	Wrench size:	Packing unit:
nickel plated	plain		SW:	
36270 5	36280 4	10 x 2 mm x G1/2"		-/-
36271 2	36281 1	12 x 2 mm x G1/2"		-/-
36272 9	36282 8	14 x 2 mm x G1/2"		-/-
36274 3	36284 2	16 x 2 mm x G1/2"		-/-
36275 0	36285 9	17 x 2 mm x G1/2"		-/-
36276 7	36286 6	18 x 2 mm x G1/2"		-/-
36277 4	36287 3	20 x 2 mm x G1/2"		-/-

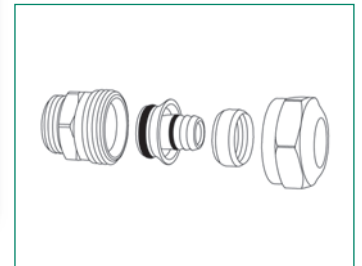
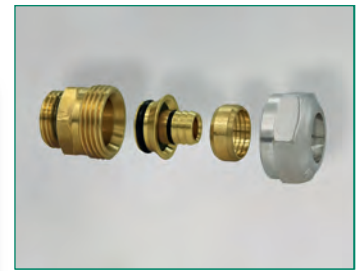

Pipe coupling for aluminium composite piping - and plastic pipes

Consisting of: 2 x compression fitting 3-pieces with brass double nipple (3/4" Eurocone), brass nickel plated or brass

Item-No.:	Item-No.:	Dimension:	Wrench size:	Packing unit:
nickel plated	plain		SW:	
36250 7	36260 6	10 x 2 mm		-/-
36251 4	36261 3	12 x 2 mm		-/-
36252 1	36262 0	14 x 2 mm		-/-
36254 5	36264 4	16 x 2 mm		-/-
36255 2	36265 1	17 x 2 mm		-/-
36256 9	36266 8	18 x 2 mm		-/-
36257 6	36267 5	20 x 2 mm		-/-

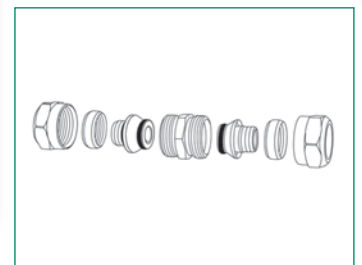

Compression fitting 2-pieces, brass nickel plated, female thread

Item-No.:	Item-No.:	Dimension:	Wrench size:	Packing unit:
nickel plated	plain		SW:	
S-1176-1/2"	-/-	G1/2" x Ø15 mm x 2 mm	24	-/500
S-1176	-/-	G3/4" x Ø15 mm x 2 mm	24	25/300

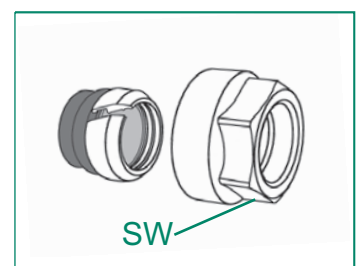

Scissors for aluminium composite- and corrugated piping

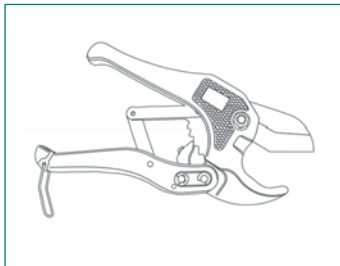

Aluminium red, cutting edge 65 Mn made of steel, suitable for pipes about 0-42 mm

Item-No.:	Packing unit:
S-3068-42	1/50

Connection nipple

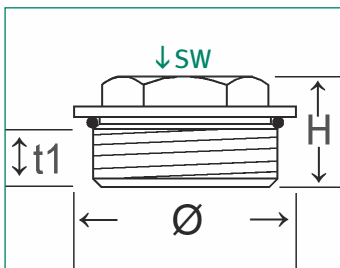

M x F, plain brass, including O-ring in groove

Item-No.:	Item-No.:	Conn.:	Thread-length:	Length:		Wrench size:	Packing unit:
plain	nickel plated		t1	Ø		SW	
S-731-Nippel	S-731-Nippel-Ni	1" x 1/2"	6	39	19,5	27	10/350

Screw connection

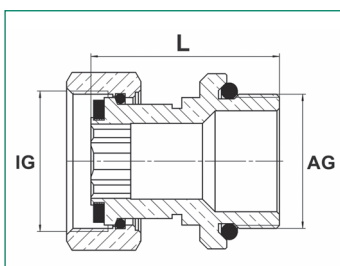

Plain brass, male thread with O-ring, union nut flat sealing, assembly with hexagon socket or external hexagon

Item-No.:	Conn.:	Length:	Wrench size:			Packing unit:
			outside	inside	screw connection	
S-3578	M x F	L				
	G 3/4" x G 3/4"	35,5	19	12	30	-/-
S-3076-bl	G 1" x G 3/4"	35,5	19	12	30	-/100

Plain brass or nickel-plated, male thread with O-ring, union nut flat sealing, assembly with hexagon socket

Item-No.:	Item-No.:	Conn.:	Length:	Wrench size:		Packing unit:
				inside	screw connection	
plain	nickel-plat.	M x F	L			
S-3131	S-3131-Ni	G 1" x G 1"	43,5	17	37	10/90

Screw connection

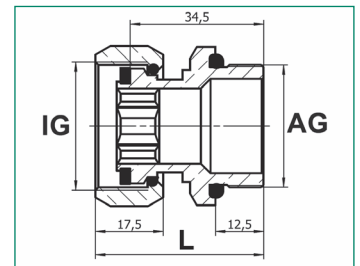
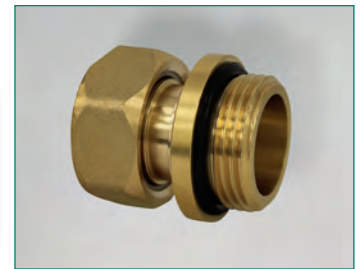

Brass nickel-plated, O-ring EPDM80°A, lead, union nut flat sealed

Item-No.:	Conn.:	Length:	Wrench size:	Wrench size:	Packing unit:
53372-Verschraubung	G 3/4" x G 1"	32,5		37	-/144
53373-Verschraubung	G 1" x G 1 1/4"	35		46	
53374-Verschraubung	G 1 1/4" x G 1 1/2"	39,5		52	

Screw connection

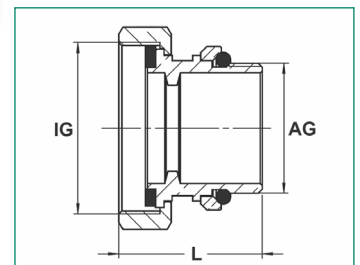

Plain brass, with thread made of AFM, 21 x 30 2 mm

Item-No.:	Item-No.:	Conn.:	Length:	Wrench size:	Packing unit:
plain	nickel-pla.	M x F	L		
S-3289	-	R 3/4" x G 1"	43,5	37	-/130

Screw connection

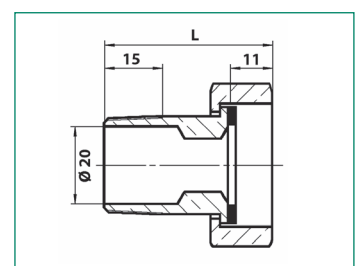

Plug

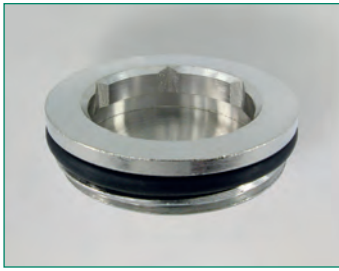

Brass nickel plated, with O-ring

Item-No.:	Conn.:	Length:		Wrench size:		Packing unit:
		H		SW	Ø	
S-2496-Ni	G1"	9		21	34,5	50/400

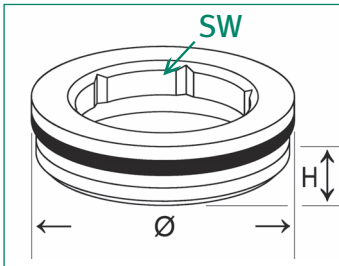

Fitting for heating distributors



F x M, plain brass, self sealing

Item-No.:	Connection:	Thread length:		Length:	Wrench size:	Packing unit:
		t1	t2	L	SW	
S-752	3/4" x 1/2"	6,5	8,5	27,5	30	25/350

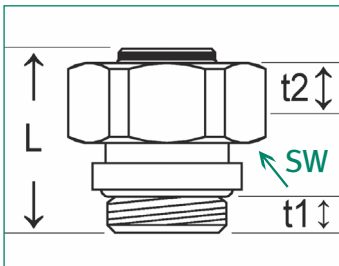

Flow nipple



Brass nickel plated, with O-ring

Item-No.:	Connection:	Thread length:		Length:	Wrench size:	Packing unit:
		t1	t2	L	SW	
S-2497-Ni	G 3/4" x G 1/2" x 26,5 mm		6,5 mm	26,5 mm	24	-/500
S-2498-Ni	G 3/4" x G 1/2" x 35 mm		8 mm	35 mm	24	-/400

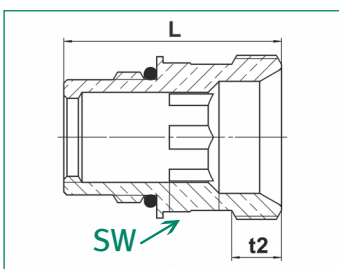

Flow nipple for heating circuit distributors

Plain brass, with O-ring

Item-No.:	Connection:	Thread length:		Length: L	Wrench size: SW	Packing unit:
		t1	t2			
S-750-32	3/4" x 1/2" x 12,5 mm	10,5	8	32 mm	27	-/396
S-1145	3/4" x 1/2" x 38,5 mm	13	12	38,5 mm	27	-/250
S-750	3/4" x 1/2" x 12,5 mm	15,5	8	43 mm	27	-/396
S-750-L	3/4" x 1/2" x 12,5 mm	15,5	8	46 mm	27	-/340

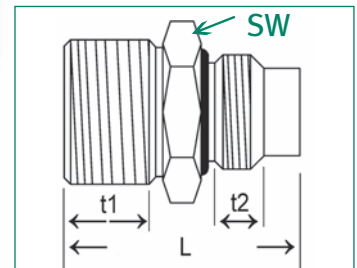

Reducing nipple

M x M, with O-ring, plain brass

Item-No.:	Connection:	Thread length:		Length: L	Wrench size: SW	Packing unit:
		t1	t2			
S-751	3/4" x 1/2" x 23,5 mm	10	6,5	23,5	24	/300
S-751b	3/4" x 1/2" x 25 mm	11	6,5	25	24	25/500

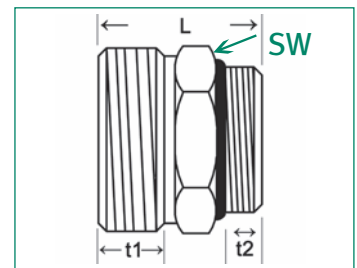

Airvent plug

Brass nickel plated, with rotating plastic head

Item-No.:	Connection:	Thread length: t1	Length:		Wrench size: SW	Packing unit:
			L	H		
54765 2	3/8"	5	22	21,5	19	50/700
54761 4	1/2"	5,5	24	20	22	50/700

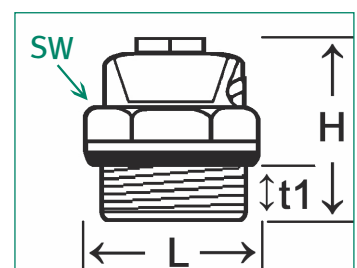

Socket wrench for heating emptying



Zamac

Item-No.:	Wrench size:	Packing unit:
54763 8 (e.g. 54761)	5 mm	100/1000

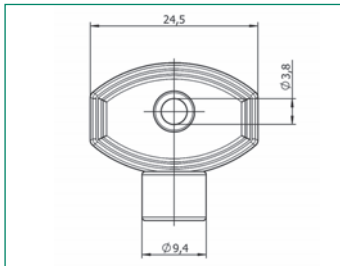

Socket wrench



Zinc die cast chromium-plated, square

Item-No.:	Wrench size:	Packing unit:
52054 9	7 mm	250/1000
52057 0 (suitable for 52051/52)	6,2 mm	300/2400

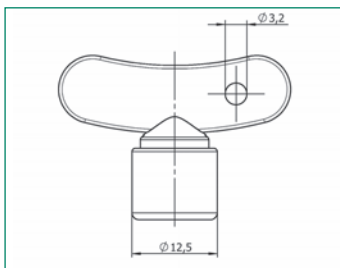

Socket wrench for sanitary upper parts



Brass chromium-plated

Item-No.:	Wrench size:	Packing unit:
52057-11712		50/450

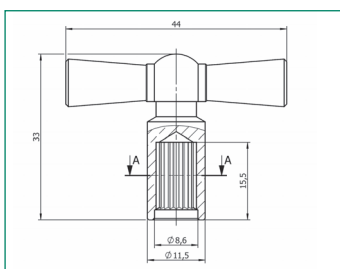

Plug

Brass nickel plated, with O-ring

Item-No.:	Connec.:	Thread length:			Wrench size:	Packing unit:
		t1	L	SW		
54760-1/4	1/4"	5,7	11,2	15	50/1000	
54760-3/8	3/8"	6	12	19	-/-	
54760-11555	1/2"	7	12,5	22	20/ 700	
54760-3/4	3/4"	8	15	24	-/-	

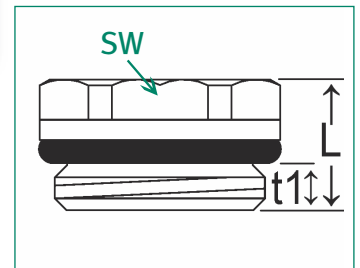

End stopper of the distributor (plumbing)

Plain brass, male threaded, with EPDM O-Ring

Item-No.:	Conn.:	Length:		Wrench size:		Packing unit:
		H	t1	SW	Ø	
S-1192	G1"	19,5	9,5	27	39	-/250

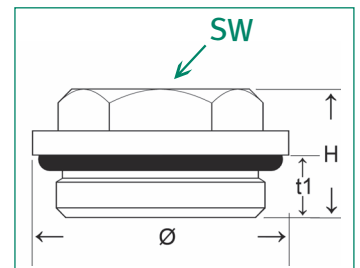

Lockable angle ball valve

Brass sandblasted, without draining valve, male threaded

Item-No.:	Connection:	Thread length:			Length:		Packing unit:
		t1	t2	t3	L	H	
S-434-3/8"	3/4" M x 3/8" F	8,5	11	9	51	56,5	4/100
S-434-1/2"	3/4" M x 1/2" M	8,5	12	9	51	56,5	4/100

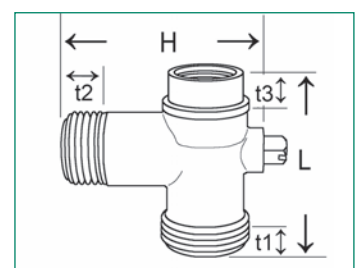

T-piece

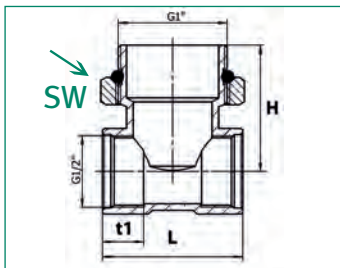

Brass, with lock nut and O-ring, F/M/F

Item-No.:	Item-No.:	Connection:	Thread length:	Length:		Wr. size:	PN:	Pack. unit:
				L	H			
plain	nickel pla.	F x M x F	t1	L	H	SW		
S-3982	S-3982-Ni	G 1/2" x G 1" x G 1/2"	12	41	37	39		

T-piece

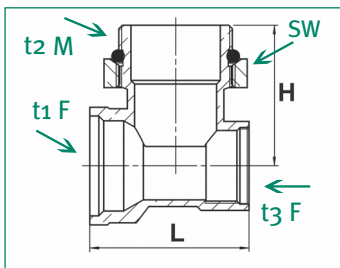

F x M x F, brass, with swiveling locknut and O-ring

Item-No.:	Thread:			Length:		Wrench size:	Packing unit:
	t1 F	t2 M	t3 F	L	H		
S-3083-1	3/4"	1"	1/2"	45	40	40	-/ 90
S-3087-1	1"	1"	1/2"	50	41	40	-/100

Spare part O-Ring for S-3083-1:

S-3083-1-O-Ring	28,7 x 3,5 mm						
-----------------	---------------	--	--	--	--	--	--

T-piece

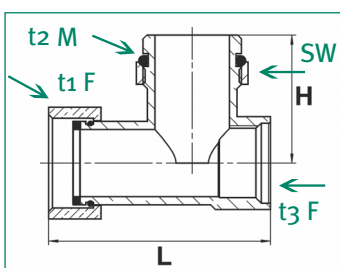

F x M x F, brass nickel plated, rigid screw connection with O-ring, one side union nut

Item-No.:	Thread:			Length:		Wrench size:	Packing unit:
	t1 F	t2 M	t3 F	L	H		
S-3083-2	3/4"	3/4"	1/2"	60	35		-/80

Screw connection

Screw connection made of brass, nickel plated, with lock nut

Item-No.:	Thread:		Length: L	Wrench size:		Packing unit:
	t1 M	t2 F		SW	SW	
S-3082-1	3/4"	3/4"	37	30		10/200
Spare parts:						
S-3082-1-O-Ring	23,47 x 2,65 mm					
S-3082-1-Dichtung	24 x 16,5 x 2,5 mm					

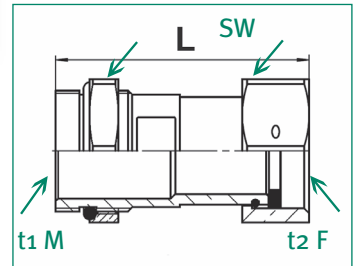

Screw connection

Screw connection made of brass, nickel plated, with union nut and sealing eye

Item-No.:	Thread:		Length: L	Wrench size:		Packing unit:
	t1 F	t2 F		SW1	SW2	
S-3082-3	1"	3/4"	24	36	30	10/200
Spare part:						
S-3082-3-Dichtung	29 x 24 x 2 mm					

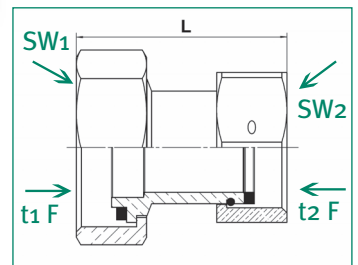
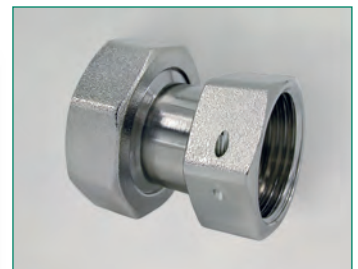

Reducing nipple

Brass nickel plated, sandblasted, with O-ring in groove

Item-No.:	Thread:		Length: L	Wrench size: SW	Packing unit:
	t1 F	t2 M			
S-3082-4	3/4"	1"	18	32	-/300
Spare part:					
S-3082-4-O-Ring	30 x 3,5 mm				

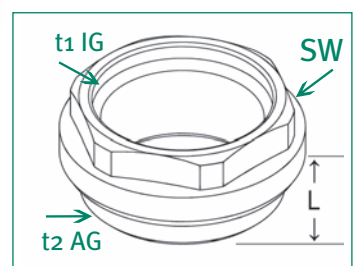
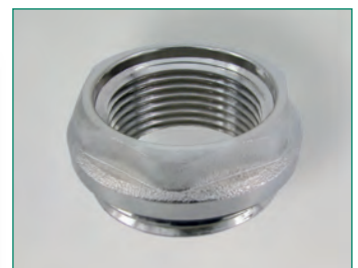

Connection nipple



M x F, brass, with O-ring in groove

Item-No.:	Item-No.:	Conn.:	Thread length:	Length:	Wrench size:	Packing unit:	
plain	nickel plated		t1	Ø	SW		
S-731-Nippel	S-731-Nippel-Ni	1" x 1/2"	6	39	19,5	27	10/350

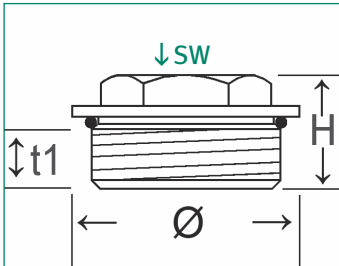

Screw connection



M x F, screw connection made of brass, nickel plated

Item-No.:	Thread:		Length:	Wrench size:	Packing unit:
	t1 M	t2 F			
S-3084-1	3/4"	1"	25	36	-/150
Spare part:					
S-3084-1-Dichtung	30 x 20 x 3 mm				

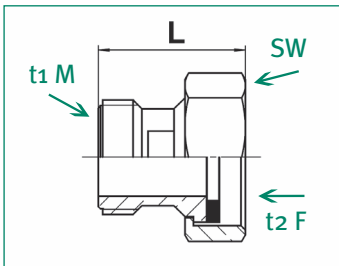

Angle 90°



M x F, brass nickel plated, with nut

Item-No.:	Thread:		Length:	Wrench-size:	Packing unit:
	t1 11 mm	t2 15,5 mm			
S-3330-01	M G 3/4"	F G 1"	35	37	-/100

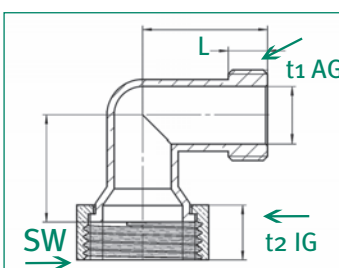

Angle

Brass nickel plated, snap ring stainless steel

Item-No.:	Thread:	Length:	Packing unit:
	Union nut x Union nut x F	L	
S-3906-Ni	G 3/4" x G 1" x G 1/2"	26/40	
S-3907-Ni	G 1" x G 1" x G 1/2"	36/40	
	Union nut x M x F		
S-3908-Ni	G 1" x G 1" x G 1/2"	36/28	

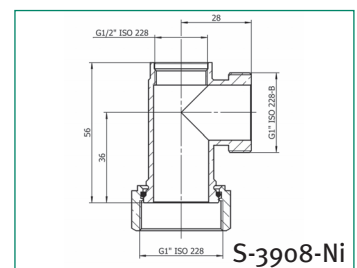
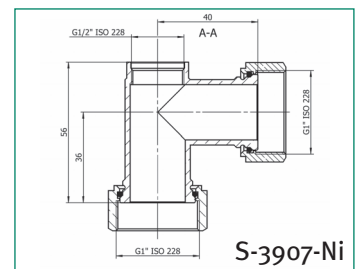
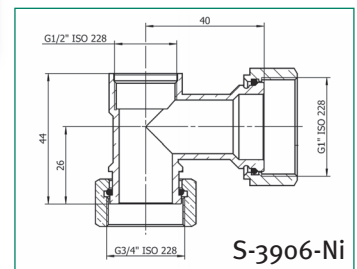

Union sets for pumps



Malleable iron, black, consisting of two union nuts, 2 unions and 2 NBR flat joints, temperature range: < 70°C

Item-No.:	Dimension:	Thread length: t1	Length: L	Wrench-size: SW	Pack. unit:
43502-2	3/4" Connection, 1 1/4" union nut	18	35	50	1/75
43503-2	1" Connection, 1 1/2" union nut	20	39	55	1/65
43504-2	1 1/4" Connection, 2" union nut	22,9	47,6	70	1/35

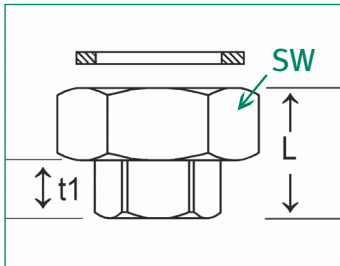

Union sets for pumps made of brass



Plain brass, consisting of two union nuts, 2 unions and 2 joints, PN 10, temperature range: - 10°C to + 110°C

Item-No.:	Dimension:	Thread length: t1	Length: L	Wrench-size: SW	Pack. unit:
34693 4	1" Connection, 1 1/2" union nut	20	38	52	-/25

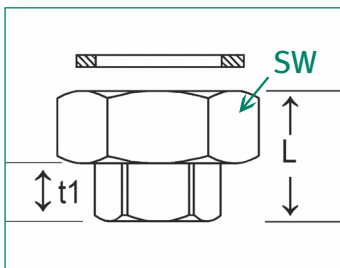

Union made of brass with nut



M x F, plain brass, 3-pieces, with nut and O-ring, metal sealing

Item-No.:	Connection: M x F	Thread length: M/F	Length: L	Wrench-size: SW1/SW2	Pack. unit:
33700 0	G 3/8" connection, G 3/8" nut	10/8	41	25/20	-/-
33701 7	G 1/2" connection, G 1/2" nut	12/12	49	30/25	-/-
33702 4	G 3/4" connection, G 3/4" nut	13/11	54	38/30	-/-
33703 1	G 1" connection, G 1" nut	15/12	60	47/37	-/-
33704 8	G 1 1/4" connection, G 1 1/4" nut	15/16	71	53/48	-/-

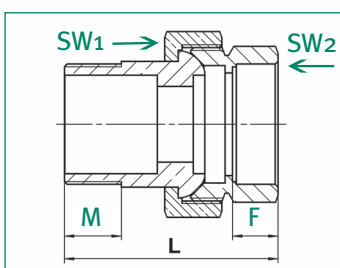

The items of the brass union nuts are not tested for compatibility with other market models.

Union made of brass with nut, angle form

M x F, plain brass, 3-pieces, angle form, with nut and O-ring, metal sealing

Item-No.:	Connection:	Thread length:	Length:	Wrench size:	Pack. unit:
	M x F	M/F	L	SW1/SW2	
33705 5	G 3/8" connection, G 3/8", nut	10/9	46	25/21	25/100
33706 2	G 1/2" connection, G 1/2", nut	12/10	53	30/25	25/100
33707 9	G 3/4" connection, G 3/4", nut	12/11,5	62,5	37/31	15/ 75
33708 6	G 1" connection, G 1", nut	12/11,5	70	46/37	5/ 50
33709 3	G 1 1/4" connection, G 1 1/4", nut	16/18	83,5	53/48	5/ 50

The items of the brass union nuts are not tested for compatibility with other market models.

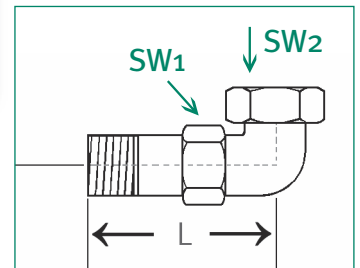

Union made of brass with nut

F x F, plain brass, with nut, metallic sealing

Item-No.:	Connection:	Thread length:	Length:	Wrench size:	Pack. unit:
	F x F	F x F	L	SW1/SW2	
33711 6	G 1/2" connection, G 1/2" nut	12/12	39	37,5/25	-/-
33712 3	G 3/4" connection, G 3/4" nut	11/ 11	37,5	47/30	-/-
33713 0	G 1" connection, G 1" nut	12/12	39,5	52/37	-/-

The parts of the brass union nut are not tested for compatibility with other market models.

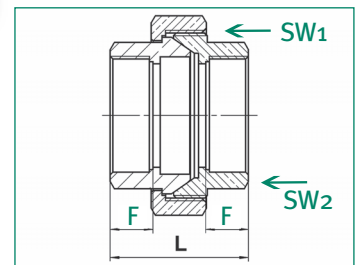

Connecting tube

Plain brass, CW 617 N, both sides male threaded

Item-No.:	Connection:	Length: L	Packing unit:
S-2592-81	G 3/4"	81 mm	10/120
S-2593-111	G 3/4"	111 mm	-/150
S-2593-131	G 3/4"	131 mm	-/150
S-2593-131-1"	G 1"	131 mm	-/150

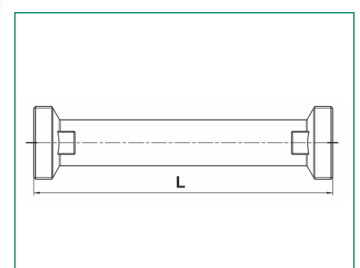

Connecting tube made of polyamide



M x M, PA66, glass fiber reinforced

Item-No.:	Connection:	Length: L	Packing unit:
S-3082-2	G3/4"	110 mm	-/80
S-3084-2	G1"	130 mm	-/80

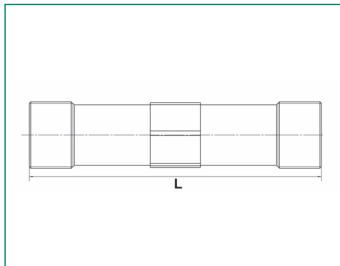

Reducer made of brass



M x F, brass nickel plated, for heat meter

Item-No.:	Connection:	Thread length:		Length: L	Wrench size: SW	Packing unit:
		t1	t2			
S-3946	G1" x G3/4"	9,5		18	30	-/300

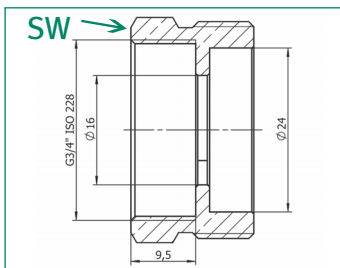

T-piece with union nut



F x M x F, plain brass, snap ring stainless steel

Item-No.:	Conne.:	Thread length:	Length:	Wrench size:	Packing unit:
	F x M x M	F/M	L	SW	
S-3412	G1" x G3/4" x G1"	16/10	60	37	-/-

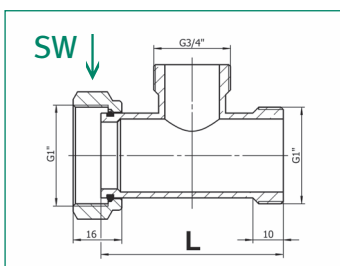

Elbow made of brass (90°)

Union nut x male thread, plain brass or nickel-plated, for distributor connectors with 1" male thread

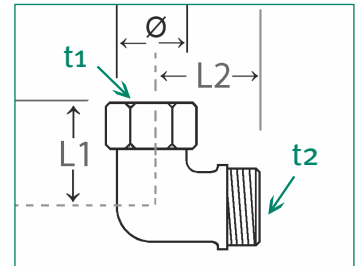

Item-No.:	Item-No.:	Con.:	Thread length:		Length:			Packing unit:
			union nut t1	male t2	L1	L2	Ø	
plain	nickel-plat.							
S-3037	S-3037-Ni	1"	9	11	46	35	24	10/70

Elbow made of brass (90°)

Both sides with union nut, plain brass or nickel-plated, for distributor connectors with 1" union nut

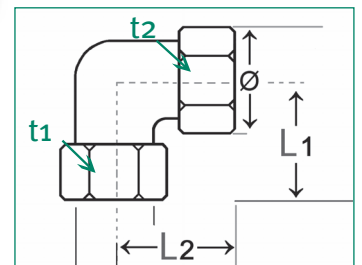

Item-No.:	Item-No.:	Con.:	Thread length:		Length:			Packing unit:
			union nut t1	union nut t2	L1	L2	Ø	
plain	nickel-plat.							
S-3407	-	G3/4"	16	16	39	39	17	-/80
S-3038	S-3038-Ni	G1"	9	9	46	44	24	-/-

OEM-bulkhead fitting with nut

F x M, brass

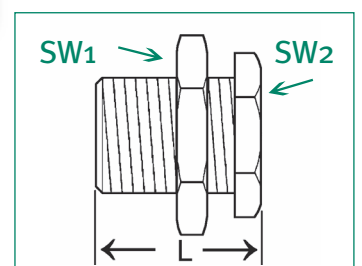

Item-No.:	Item-No.:	Connection:	Length:	Wrench size:		Packing unit:
				SW 1	SW 2	
plain	nickel pla.		L			
S-451		G1/8" x M16 x 1,5	18	22	19	50/1000
S-452	S-452-Ni	G1/4" x M20 x 1,5	25	27	24	25/ 450
S-453	S-453-Ni	G1/2" x M28 x 1,5	33	36	32	25/ 200

OEM-double nipple

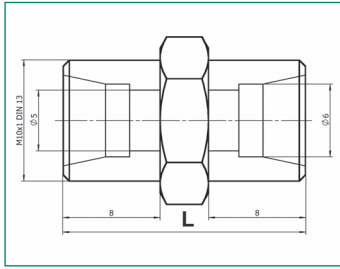

M x M, brass nickel plated, wrench size 12

Item-No.:	Connection:	Length: L	Packing unit:
S-2277	M10 x 1	20 mm	-/1000

Assembly plug

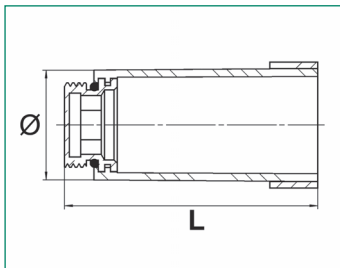

Plastic, brass connection thread, with hexagon socket, according to DIN 1988-2, for pressure tests, venting and rinsing, permanent use possible

Item-No.:	Color:	Connection:	Length: L	Ø	Packing unit:
36391-B	blue	1/2"	75 mm	30 mm	10/400
36391-R	red	1/2"	75 mm	30 mm	10/400
36391-W	white	1/2"	75 mm	30 mm	10/400
36392-B	blue	3/4"	79 mm	34,5 mm	-/250
36392-R	red	3/4"	79 mm	34,5 mm	-/250
36392-W	white	3/4"	79 mm	34,5 mm	-/250

Spare part:

36391-O-Ring	EPDM	Ø18 x 2,5 mm			
36392-O-Ring	EPDM	Ø21,8 x 3,1 mm			

Assembly plug

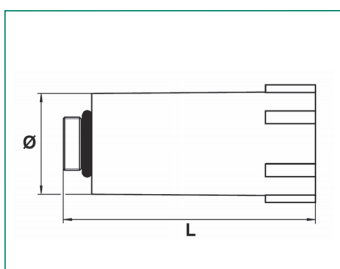
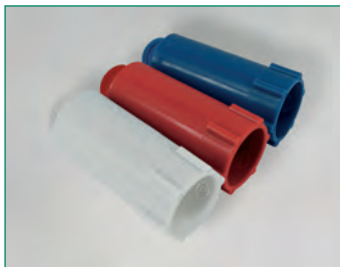

Completely made of plastic, according to DIN 1988-2, for one-off leak test, not suitable for permanent use

Item-No.:	Color:	Connection:	Length: L	Ø	Packing unit:
36394-B	blue	3/8"	75 mm	30 mm	25/400
36394-R	red	3/8"	75 mm	30 mm	25/400
36394-W	white	3/8"	75 mm	30 mm	25/400
36395-B	blue	1/2"	75 mm	30 mm	-/400
36395-R	red	1/2"	75 mm	30 mm	-/400
36395-W	white	1/2"	75 mm	30 mm	-/400

Assembly plug

Completely made of plastic with 3 x male thread (G 3/8", G 1/2", G 3/4"), not suitable for permanent use

Item-No.:	Color:	Connection:	Length: L	Ø	Packing unit:
36396-B	blue		61,5 mm		50/400
36396-R	red		61,5 mm		50/400

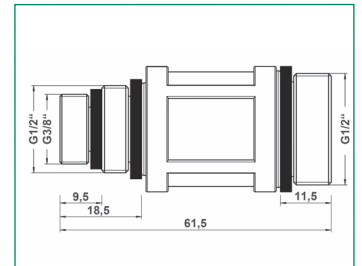

Drain construction plugs

Made entirely of plastic, blue, for drain pipes Ø 32/40/50 mm, universal

Item-No.:	Color:	Dim.:	Length: L	Ø	Pack. u.:
36399 3	blue		122 mm	32/40/50	5/300

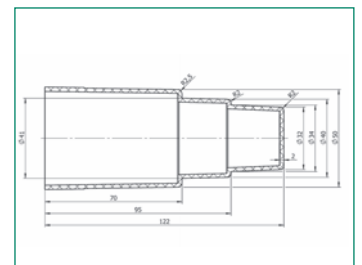
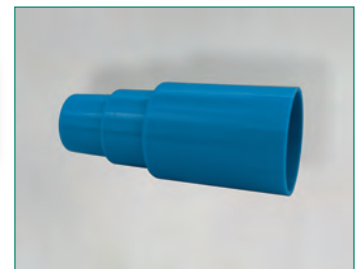

Armoured hoses: flexible hoses for the heating sector

Stainless steel braiding, brass connecting fittings nickel plated, inner hose EPDM,
working pressure: max. 20 bar, operating temperature: -10° C bis + 75° C

Armoured hose



Connection: union nut x male thread, inner hose EPDM

Item-No.:	Length (mm):	Connection:	Hose Ø: inside/outside	Packing unit:
52816 3	500	1/2" f x m	16 mm/22 mm	loose
52817 0	750	1/2" f x m	16 mm/22 mm	loose
52818 7	1000	1/2" f x m	16 mm/22 mm	loose
52819 4	1500	1/2" f x m	16 mm/22 mm	loose
52800 2	1000	3/4" f x m	13 mm/18 mm	loose
52801 9	1500	3/4" f x m	13 mm/18 mm	loose
52802 6	2000	3/4" f x m	13 mm/18 mm	loose
52803 3	2500	3/4" f x m	13 mm/18 mm	loose
52804 0	3000	3/4" f x m	13 mm/18 mm	loose
52836 1	500	3/4" f x m	19 mm/27 mm	loose
52837 8	750	3/4" f x m	19 mm/27 mm	loose
52838 5	1000	3/4" f x m	19 mm/27 mm	loose
52839 2	1500	3/4" f x m	19 mm/27 mm	loose
52824 8	300	1" f x m	25 mm/34 mm	loose
52823 1	400	1" f x m	25 mm/34 mm	loose
52825 5	500	1" f x m	25 mm/34 mm	loose
52827 9	750	1" f x m	25 mm/34 mm	loose
52806 4	1000	1" f x m	25 mm/34 mm	loose

Armoured hose



Connection: union nut x union nut, inner hose EPDM

Item-No.:	Length (mm):	Connection:	Hose Ø: inside/outside	Packing unit:
52808 8	500	1/2" f x f	16 mm/22 mm	loose
52809 5	750	1/2" f x f	16 mm/22 mm	loose
52810 1	1000	1/2" f x f	16 mm/22 mm	loose
52811 8	1500	1/2" f x f	16 mm/22 mm	loose
52832 3	500	3/4" f x f	19 mm/27 mm	loose
52833 0	750	3/4" f x f	19 mm/27 mm	loose
52834 7	1000	3/4" f x f	19 mm/27 mm	loose
52835 4	1500	3/4" f x f	19 mm/27 mm	loose
52842 2	300	1" f x f	25 mm/34 mm	loose
52844 6	500	1" f x f	25 mm/34 mm	loose
52845 3	750	1" f x f	25 mm/34 mm	loose
52846 0	1000	1" f x f	25 mm/34 mm	loose
52847 7	1500	1" f x f	25 mm/34 mm	loose

Replacement joint

Replacement fiber joint for flexible hoses

52766-Dichtung	union nut 1/2"		10
52800-Dichtung	union nut 3/4"		10
52822-Dichtung	union nut 1"		10

F x F, sand filter made of red brass (CC491K) with fine-mesh screen made of stainless steel 1.4301, PN 20 for max. 120°C

Socket strainers, red brass

Item-No.:	Conn.:	Mesh size:	Thread length:		Length:		Wrench size:	Packing unit:
			IG	IG	L	H		
66400 7	3/8"	-	-	-	-	-	-	20/180
66401 4	1/2"	0,5	12,5	12,5	56,5	50	24,5	4/ 96
66402 1	3/4"	0,5	13	13	66,5	65	30,5	6/ 60
66403 8	1"	0,5	14	14	76	72	37,5	4/ 40
66404 5	1 1/4"	0,8	16	16	96	85	47,5	6/ 24
66405 2	1 1/2"	0,8	17	17	105	100	54	10/ 20
66406 9	2"	0,8	19	19	125	120	66	12/ 12
66407 6	2 1/2"	0,8	25	25	147	150	83	2/ 20
66408 3	3"	0,8	28	28	174	180	96	-/-
66409 0	4"	0,8	29	29	210	210	123	-/-

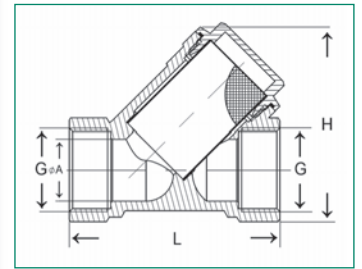

Spare parts for socket strainers, red brass

Item-No.:	Conn.:	Item-No.:	Conn.:	Item-No.:	Conn.:
Spare filter stainless steel:		Spare caps brass:		Replacement seals:	
66400-Filter	3/8"	66400-Kappe	3/8"	66400-Dichtung	3/8"
66401-Filter	1/2"	66401-Kappe	1/2"	66401-Dichtung	1/2"
66402-Filter	3/4"	66402-Kappe	3/4"	66402-Dichtung	3/4"
66403-Filter	1"	66403-Kappe	1"	66403-Dichtung	1"
66404-Filter	1 1/4"	66404-Kappe	1 1/4"	66404-Dichtung	1 1/4"
66405-Filter	1 1/2"	66405-Kappe	1 1/2"	66405-Dichtung	1 1/2"
66406-Filter	2"	66406-Kappe	2"	66406-Dichtung	2"
66407-Filter	2 1/2"	66407-Kappe	2 1/2"	66407-Dichtung	2 1/2"
66408-Filter	3"	66408-Kappe	3"	66408-Dichtung	3"
66409-Filter	4"	66409-Kappe	4"	66409-Dichtung	4"

F x F, body made of red brass (CC491K), other pieces brass, full flow, sealing made of EPDM, PN 16 for max. 80°C, handwheel made of steel, painted red

Gate valve, red brass

Item-No.:	Conn.:	Thread length:	Length:		Ø wheel	Packing unit:
		t1	L	H		
66440 3	3/8"	9	38	66	45	-/160
66441 0	1/2"	9	38	68	45	-/140
66442 7	3/4"	10	45	78	50	-/100
66443 4	1"	11	48	92	55	-/ 70
66444 1	1 1/4"	11	51	108	60	-/ 40
66445 8	1 1/2"	13	58	125	70	-/ 35
66446 5	2"	13	62	145	80	-/ 20
66447 2	2 1/2"	16	76	175	100	-/ 14
66448 9	3"	16	80	200	100	-/ 12
66449 6	4"	19	96	240	120	-/ 6

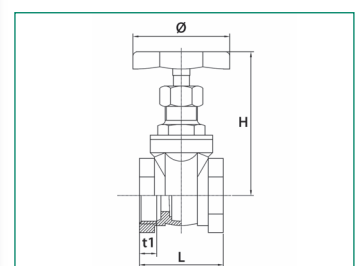

Swing check valve, red brass

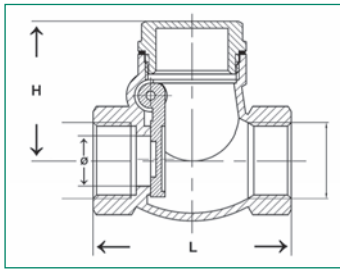

F x F, body made of red brass (CC491K), other pieces brass, full flow, metallic sealing, only suitable for vertical installation

Item-No.:	Conn.:	Length:		Wrench size: SW1	Ø A	PN:	Packing unit:
		L	H				
66460 1	3/8"			-		16	
66461 8	1/2"	55	39	-	14	16	
66462 5	3/4"	62	46,5	-	20	16	
66463 2	1"	72	53,5	-	25	16	
66464 9	1 1/4"	82	62,5	-	30	16	
66465 6	1 1/2"	90	65,5	55	35	16	
66466 3	2"	105	73	-	47	16	

Socket strainers

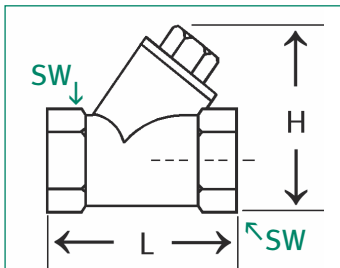

F x F, sand filter made of brass with fine-mesh screen made of stainless steel 1.4301

Item-No.:	Conn.:	Mesh size: mm	Thread length:		Length:		Wrench size: SW:	Packing unit:
			F	F	L	H		
51400 5	3/8"	0,5	11,5	11,5	54	48,5	25	16/128
51401 2	1/2"	0,5	11,5	11,5	54	48,5	25	15/ 90
51402 9	3/4"	0,5	11	11	70	63	31	15/ 60
51403 6	1"	0,5	12	12	78	70	39	10/ 40
51404 3	1 1/4"	1,3	16	16	96	89	48	5/ 20
51405 0	1 1/2"	1,3	22	22	120	-	55	2/ 16
51406 7	2"	1,3	26	26	150	-	70	2/ 8

Gate valve, brass

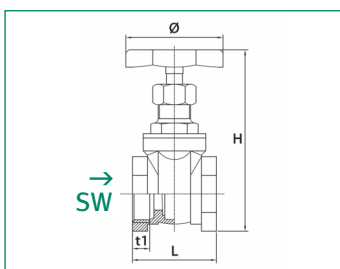

F x F, pressure stage fore this series PN 10, red enamelled handwheel, seals made of PTFE, stuffing box, up to and including 2" hot-pressed

Item-No.:	Conne.:	Thread length: t1	Length:		Wrench size: SW	Ø wheel	Packing unit:
			L	H			
50020 6	3/8"	7	37	74	21	45	10/120
50021 3	1/2"	7	37	74	24	50	20/ 80
50022 0	3/4"	10	40	81	30	50	20/ 80
50023 7	1"	10	44,5	93	36	60	15/ 60
50024 4	1 1/4"	11,5	50,5	114	46	60	5/ 30
50025 1	1 1/2"	11,5	53	130	53	70	12/ 24
50026 8	2"	14	60	152	65	70	3/ 12
50027 5	2 1/2"	14	66	188	82	88	-/ 8
50028 2	3"	21	83	240	94	110	-/ 6
50029 9	4"	16	80	290	123	130	-/ 3

F x F, pressure stage fore this series PN 16, red enamelled handwheel, seals made of PTFE, stuffing box, up to and including 2" hot-pressed, full flow, heavy version

Item-No.:	Conneс.: t1	Thread length: t1	Length: L	Height: H	Wrench size: SW	Packing unit:
50040 4	3/8"	9	40	78	21	20/80
50041 1	1/2"	10,5	41,5	89	25	20/80
50042 8	3/4"	12	46	100	31,5	15/ 45
50043 5	1"	13	50	118	37	10/ 40
50044 2	1 1/4"	13,5	57	136	47,5	3/ 18
50045 9	1 1/2"	13,5	60	151	53	2/ 12
50046 6	2"	13,5	67,5	171	65,5	3/ 12
50047 3	2 1/2"	19	79,5	216	83	-/ 8
50048 0	3"	19	82,5	245	97,5	-/ 6
50049 7	4"	19,5	96	294	123	-/ 3

Gate valve, brass

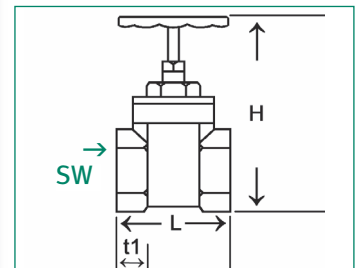

Pressure stage fore this series PN 10, red enamelled handwheel, seals made of PTFE, on both sides solder terminal, hot-pressed

Item-No.:	Conneс.: t1	Thread length: t1	Length: L	Height: H	Wrench size: SW	Packing unit:
50010 7	12 mm	10	36	75	20	10/100
50011 4	15 mm	11,5	40	78	20	10/ 50
50012 1	18 mm	15	46,5	79	20	10/ 50
50013 8	22 mm	16,5	52	84,5	20	10/ 50
50014 5	28 mm	20	62,5	100	25	5/ 50

Gate valve, brass

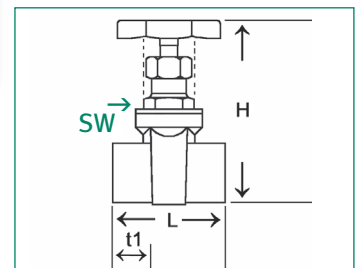

Reference:

For technical reasons, it is **not possible** to replace the upper part of the sleeve valves!

Replacement handwheels for gate valves

Painted red

Item-No.:	for:	Wrench size + Ø:	for Item:	and for Item-No.:
50015 2	3/8" - 1"	6 mm + 50 mm	50010-50013	50020-50023
50016 9	1 1/4" + 1 1/2"	6 mm + 58 mm	50014	50024-50025
50017 6	2"	6 mm + 70 mm		50026
50018 3	3" + 4"	10 mm + 130 mm	50028-50029	50048-50049

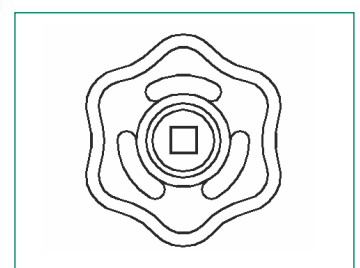

Angle seat valve, forged brass

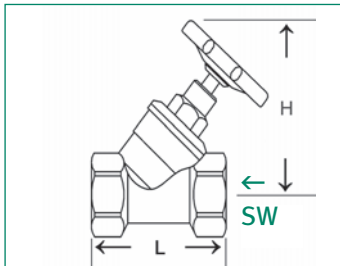

Market model, pressure stage fore this series PN 10, valve cone with rubber seal (EPDM), without draining, both sides female threaded, rising valve stem, double O-ring, hand-wheel made of durable plastic

Item-No.:	Conn.:	Thread length:	Length:	Heigth:	Wre.-size:	Packing unit:
		t1	L	H	SW	
52311 3	1/2"	12	56	73	25	15/90
52312 0	3/4"	13	63	80	30	14/56
52313 7	1"	15,5	76	103	37	6/36
52314 4	1 1/4"	21,5	95	103	48	4/ 16

On request 1 1/2" and 2"

Angle seat valve, forged brass

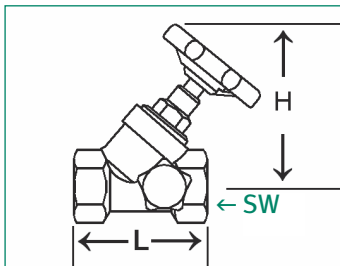

Description as item 52311-52314, however with draining, PN 10

Item-No.:	Conn.:	Thread length:	Length:	Heigth:	Wre.-size:	Packing unit:
		t1	L	H	SW	
52301 4	1/2"	12	56	73	25	13/78
52302 1	3/4"	13	63	80	30	11/ 44
52303 8	1"	15,5	76	103	37	6/ 36
52304 5	1 1/4"	21,5	95	103	48	4/ 16

On request 1 1/2" and 2"

Angle seat valve, forged brass

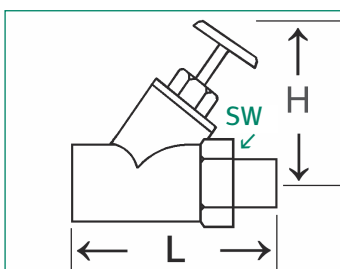

Description as item 52311-52314, without draining, with solder terminals, PN 10

Item-No.:	Dimension:	Length:	Heigth:	Wrench size:	Packing unit:
		L	H	SW	
52325 0	12 mm	57	73	23	20/80
52326 7	15 mm	68	80	29	-/-
52327 4	18 mm	75,5	103	33	16/ 64
52328 1	22 mm	84	103	36	10/ 40
52329 8	28 mm	103	103	46	-/-

Angle seat valve, forged brass

Description as item 52311-52314, however with draining, with solder terminations

Item-No.:	Dimension:	Length:	Heigth:	Wrench size:	Packing unit:
		L	H	SW	
52320 5	12 mm	60	64	23	18/72
52321 2	15 mm	68	65,5	29	15/60
52322 9	18 mm	76,5	67,5	33	12/48
52323 6	22 mm	84	71	36	10/40
52324 3	28 mm	103	92	46	-/32

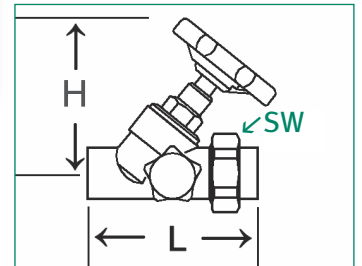

Angle seat check valve

Brass hot-pressed, both sides female threaded, without draining, PN 10

Item-No.:	Conn.:	Thread length:	Length:	Heigth:	Wrench size:	Packing unit:
seals made of EPDM		t1	L	H	SW	
52341 0	1/2"	12	54	53	25	22/88
52342 7	3/4"	13	63	60	30	16/ 64
52343 4	1"	15,5	76	78	37	10/ 40
52344 1	1 1/4"	21,5	95	92	48	5/ 20
52345 8	1 1/2"	25	130	108	54	2/ 16
52346 5	2"	28	150	137	70	1/ 8
seals made of silicone						
52347-10948	2 1/2"	30,2	180	178	85	-/-
52349-10948	3"	33,3	210	200	100	-/-

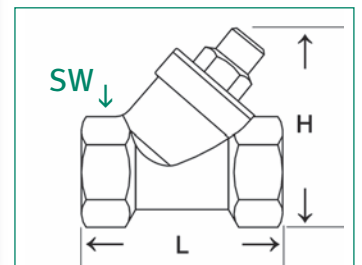

Spare part spring for angle seat check valves

Stainless steel

Item-No.:	for item:	Conn.:
52345-Feder	52345-10948	1 1/2"
52346-Feder	52345/48-10948	2"

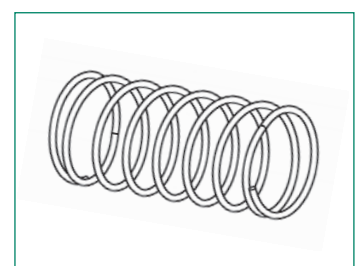

Spare part plunger for angle seat check valves

with sealing

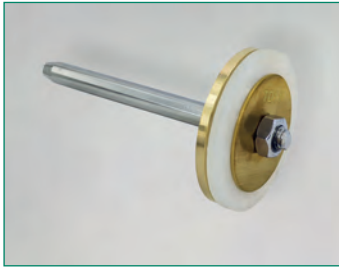
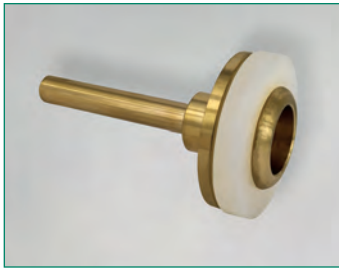

Item-No.:	for item:	Conn.:	Packing unit:
52345-Stößel	52345-10948	1 1/2"	10/150
52346-Stößel	52346/48-10948	2"	10/100
52347-Stößel-VA	52347-10948	2 1/2"	5/ 50
52349-Stößel-VA	52349-10948	3"	5/ 40

Replacement sealing, silicone

52345-Dichtung	52345-10948	1 1/2"	-/-
52346-Dichtung	52346-10948	2"	-/-

Spare part lid for angle seat check valves

Plain brass, with O-ring

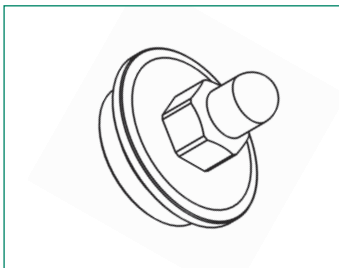

Item-No.:	for item:	Conn.:	Packing unit:
52345-Deckel	52345-10948	1 1/2"	-/40
52346-Deckel	52346-10948	2"	-/-
52347-Deckel	52347-10948	2 1/2"	-/-
52349-Deckel	52349-10948	3"	-/-

Replacement O-ring, silicone

52345-O-Ring	52345-10948	1 1/2"	-/-
52346-O-Ring	52346-10948	2"	-/-
52347-O-Ring	52347-10948	2 1/2"	-/-
52349-O-Ring	52349-10948	3"	-/-

Spare parts body for angle seat check valves

without illu.

Item-No.:		Conn.:
52345-Körper	Body, plain brass	1 1/2"
52346-Körper	Body, plain brass	2"
52347-Körper	Body, plain brass	2 1/2"

Spare parts set for angle seat check valves

without illu.

Item-No.:		Conn.:
52345-REP-Set	consisting of lid,- plunger- and spring	1 1/2"
52346-REP-Set	consisting of lid,- plunger- and spring	2"

Angle seat check valve with solder connection

Brass hot-pressed, without draining, PN 10

Item-No.:	Dimension:	Length:	Heigth:	Wrench size:	Packing unit:
		L	H	SW	
52330 4	12 mm	57		23	-/-
52331 1	15 mm	68	54	29	-/-
52332 8	18 mm	75,5	54	33	-/-
52333 5	22 mm	84	61	36	12/48
52334 2	28 mm	103	80	46	6/24

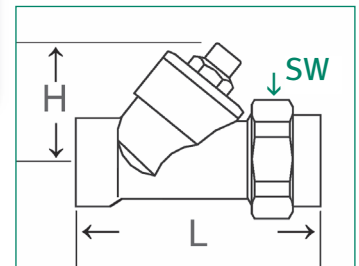

Brass hot-pressed, market model, valve cone with rubber seal, without draining, both sides female threaded, upper part with rising stem, double O-ring seal, PN 10

Item-No.:	Conne.:	Thread length:	Length:	Heigth:	Wrench size:	Packing unit:
		t1			SW	
52361 8	1/2"	13	52	62	25	14/112
52362 5	3/4"	14,5	61	70	30	8/ 64
52363 2	1"	16,5	72	92	37	6/ 36

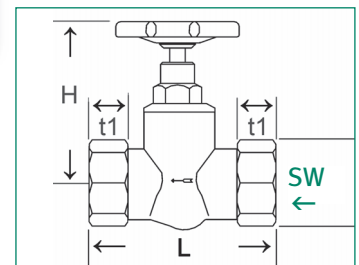

Description as item 52361-52363, however with draining, PN 10

Item-No.:	Conne.:	Thread length:	Length:	Heigth:	Wrench size:	Packing unit:
		t1			SW	
52351 9	1/2"	12	66	62	25	15/60
52352 6	3/4"	14	74	70	30	10/40
52353 3	1"	17	88	92	37	4/ 24
52354 0	1 1/4"					-/-

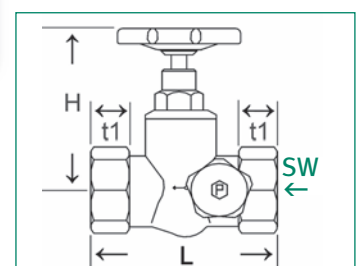

Spare parts for straight way valves



Drain valve made of brass, with O-ring

Item-No.:	Connec.:	Thread length: t1	Length: L	Wrench size: SW	Packing unit:
52298 7	1/4" male	4	28	20	-/ 600

Plug made of brass, with O-ring (without illu.)

52299 4	1/4"	4,2	8,7	17	200/3000
---------	------	-----	-----	----	----------

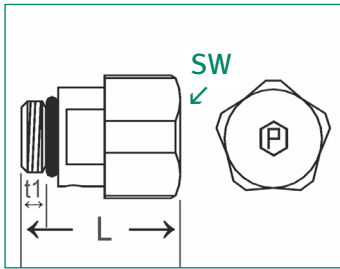

Spare parts for straight way valves



Upper valve part with handwheel made of durable plastic, green

Item-No.:	Conn.:	Thread length: t1	Length: wheel - Ø	Heigth: H	Wrench size: SW	Packing unit:
52290 1	3/8"	5,5	50	62	15	40/240
52291 8	1/2"	6	50	63,5	15	30/180
52292 5	3/4"	7	50	72	15	-/ 150
52293 2	1"	7,5	60	94	19	-/ 96
52294 9	1 1/4"	10	60	104	22	10/ 60
52295 6	1 1/2"	9	80	110	27	5/ 30
52296 3	2"	9,5	80	120	27	4/ 24

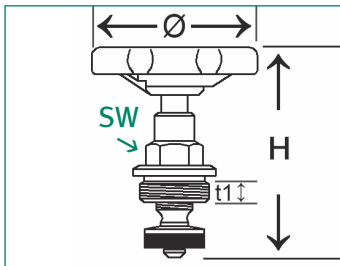

Spare parts for straight way valves



Handwheel made of durable plastic, green, with screw

Item-No.:	Connection:	Length:		Wrench size:		P. u.:
		wheel - Ø	Height	SW	square shaft	
52281 9	1/2" + 3/4"	50	15	16	6	-/10
52282 6	1" + 1 1/4"	60	15	16	6	-/10

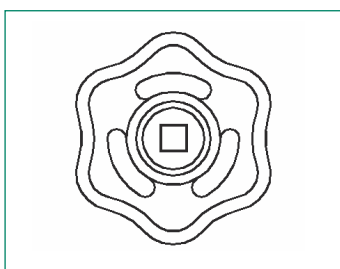

F x M, brass, heavy version, closing cone with rubber seal, straight type, only suitable for vertical installation

Item-No.:	Conne.: F x M	Thread length: F x M	Length:		Wrench size:		Packing unit:
			L	Ø	SW1	SW2	
51023 6	1"	16/18	90	56	38	38	3/27
51024 3	1 1/4"	20/18	100	68	48	48	4/16
Spare parts o-ring EPDM:							
51025 0	1"	for 51023	48 x 2 mm				
51026 7	1 1/4"	for 51024	58 x 2,5 mm				

Pump check valve

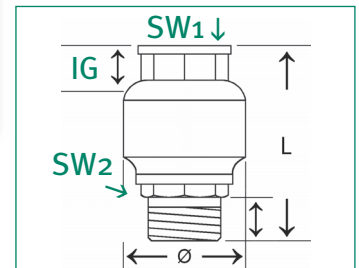

F x M, brass, heavy version, closing cone with rubber seal, angle type, only suitable for vertical installation

Item-No.:	Conne.: F x M	Thread length: F x M	Length: L	Height: H	Wrench size:		Packing unit:
					SW1	SW2	
51033 5	1"	14/18	50	50	23	38	2/16
51034 2	1 1/4"	21/20	56	58	23	48	2/16
Spare parts o-ring EPDM:							
51035 9	1"	for 51033	48 x 2 mm				
51036 6	1 1/4"	for 51034	58 x 2,5 mm				

Pump check valve

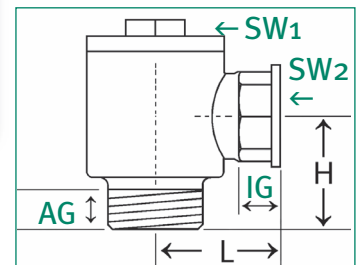

Spare parts for pump check valves

Complete, with seal (illu.)

Item-No.:	for item-No.:	Connection:	Packing unit:
51020 5	51023 6 + 51033 5	1"	10/250
51030 4	51024 2 + 51034 2	1 1/4"	10/100

Rubber seal for sealing cone (without illu.)

Item-No.:	for item-No.:		
51021 2	51020 5		-/-
51031 1	51030 4		-/-

Closing cone with seal

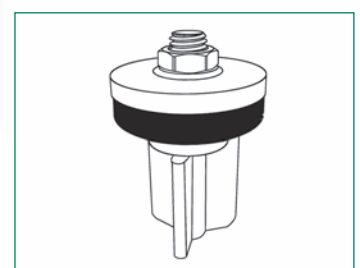

Foot valve made of brass

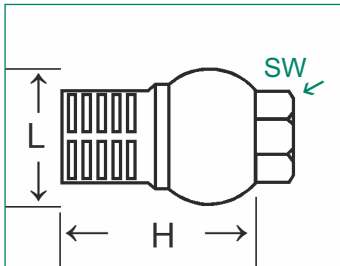
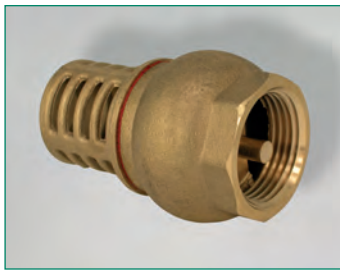

For pumps, suction strainer with slots, valve clapper made of brass with rubber seal, only suitable for vertical installation

Item-No.:	Connection:	Length: L	Height: H	Wrench size: SW	Packing unit:
51321 3	1/2"	39	60	27	12/96
51322 0	3/4"	45	69	34	12/48
51323 7	1"	51	80	40	18/54
51324 4	1 1/4"	61	92	49	8/ 24
51325 1	1 1/2"	68	100	55	3/ 18
51326 8	2"	80	117	66	2/ 12

Foot valve for driven wells made of brass

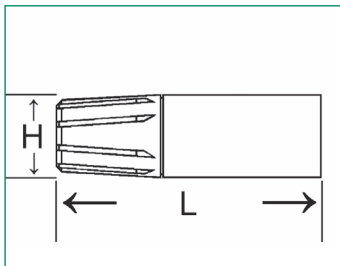

With suction strainer, valve clapper made of brass with rubber seal, only suitable for vertical installation

Item-No.:	Outside Ø	Connec.:	Thread length:	Length: L	Height: H	Packing unit:
51352 7	app. 31,0 mm	3/4"	17	99	30,5	10/60
51353 4	app. 36,5 mm	1"	20	114	36	16/48

Sealing cone with rubber moulded seal

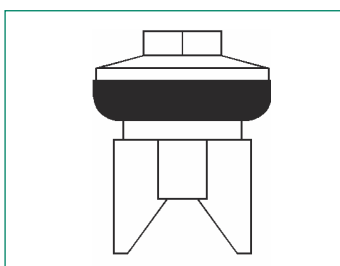

Spare parts for pump check valves

Item-No.:	Matches to item:	Connection:	Packing unit:
51090 8	51083	1"	25/350
51088 5	Seal loose	1"	-/-
51089 2	Seal loose	1 1/4"	-/-

Spare parts for pump check valves

Item-No.:	Match to item:	Connection:	Packing unit:
51080 9	51083	1"	10/250

Closure cap with seal

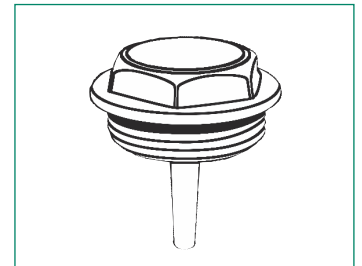

F x F, plain brass, socket check valve, closure clap without spring, metallic sealing, only suitable for vertical installation

Swing check valve made of brass

Item-No.:	Conne.:	Length: L	Height: H	Wrench size:		PN:	Packing unit:
				SW1	SW2		
51061 8	1/2"	47	48,5	25	20	16	25/100
51062 5	3/4"	53	56,5	30	24	16	10/120
51063 2	1"	68	65	38	27	16	10/ 40
51064 9	1 1/4"	74	78	48	30	10	6/ 24
51065 6	1 1/2"	86	88	54	38	10	4/ 16
51066 3	2"	100	103	68,5	40	10	3/ 12
51067 0	2 1/2"	104	124	83	51,5	10	1/ 8
51068 7	3"	125	137	95,5	62,5	10	1/ 6
51069 4	4"	162	171	123	81,5	10	1/ 2

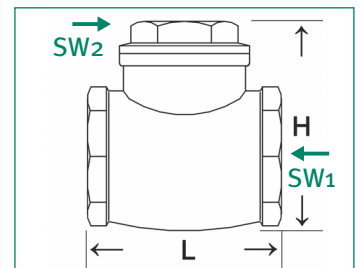

Check valve made of brass

With double venting, heavy version, stainless steel swing check valve, 2 bleed screws, therefore particularly suitable for well construction, in winter no disassembly or risk of frost in the well system

Item-No.:	Conne.:	Thread length:	Length: L	Height: H	Wrench size: SW	Packing unit:
51043 4	1"	13	71	50	39	6/ 30
51044 1	1 1/4"	15	82	62	49	4/ 20
51045 8	1 1/2"	15	92,5	73	56	2/ 24

Spare parts:

51048 9	Vent screw
51049 6	Replacement seal

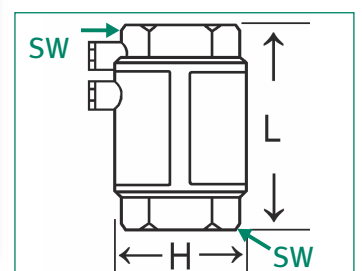

Check valve made of brass (System York)

F x F, with spring, valve disc made of plastic with rubber seal, also suitable for horizontal mounting

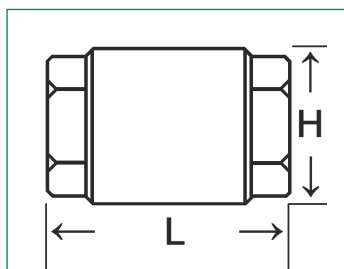
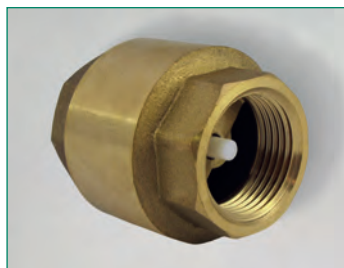

Item-No.:	Connection:	Length:		PN:	Packing unit:
		L	H		
51000 7	3/8"	45	34	10	10/120
51001 4	1/2"	45	34	10	10/120
51002 1	3/4"	48	42	10	10/100
51003 8	1"	53	47	10	6/ 60
51004 5	1 1/4"	58	59	8	5/ 25
51005 2	1 1/2"	69	68	8	6/ 24
51006 9	2"	77	80	8	2/ 18
51007 6	2 1/2"	-	-	-	2/ 8
51008 3	3"	-	-	-	2/ 8
51009 0	4"	-	-	-	2/ 4

Check valve made of brass (System York)

F x M, with spring, valve disc made of plastic with rubber seal, also suitable for horizontal mounting

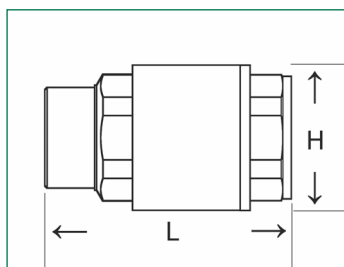

Item-No.:	Connection:	Length:		PN:	Packing unit:
		L	H		
51122 6	3/4"	61	36,5	10	15/90
51123 3	1"	69	44	10	15/60

Check valve made of brass (System York)

M x M, with spring, valve disc made of plastic with rubber seal, also suitable for horizontal mounting

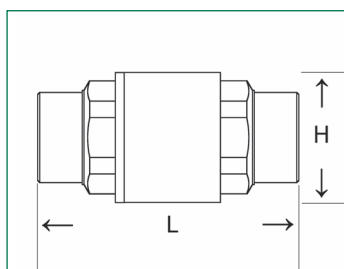

Item-No.:	Connection:	Length:		PN:	Packing unit:
		L	H		
51132 5	3/4"	70	36,5	10	15/ 75
51133 2	1"	80	44	10	12/48

Check valve made of brass (Europa)

Long version, with spring, valve disc made of brass with rubber seal, also suitable for horizontal mounting

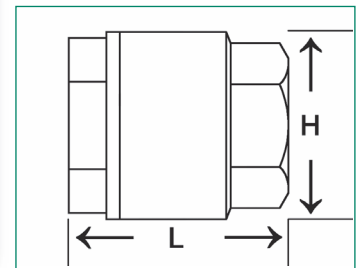

Item-No.:	Connection:	Length:		PN:	Packing unit:
		L	H		
51101 1	1/2"	58,5	34,5	25	10/170
51102 8	3/4"	65	41,5	25	8/120
51103 5	1"	74,5	48	25	6/ 88
51104 2	1 1/4"	83	60,5	18	6/ 54
51105 9	1 1/2"	93	71	18	4/ 36
51106 6	2"	101	87	18	2/ 24
51107 3	2 1/2"	-	-	-	1/ 12
51108 0	3"	-	-	-	1/ 8

With spring, heavy Euro version, brass valve cone, stainless steel pressure washer, gasket EPDM

Check valve made of brass

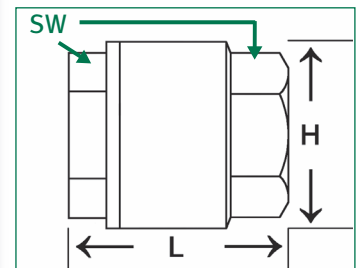

Item-No.:	Connection:	Length:		Wrench size	PN:	Packing unit:
		L	H			
51140 0	3/8"	54	34,5	21	25	15/90
51141 7	1/2"	57	34,5	25	25	15/90
51142 4	3/4"	60	42	31	25	12/48
51143 1	1"	73	48	40	25	9/ 36
51144 8	1 1/4"	83	60,5	50	16	6/ 24
51145 5	1 1/2"	93	70,8	55	16	2/ 8
51146 2	2"	100	87	67	16	2/ 8
51147 9	2 1/2"	120	118,6	88	10	1/ 6
51148 6	3"	138,5	140	100	10	1/ 4
51149 3	4"	158	154	126	10	1/ 3

With spring, valve disc made of plastic with rubber seal, fine mesh strainer made of stainless steel

Foot valve made of brass

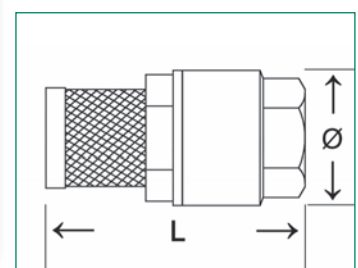

Item-No.:	Connection:	Length:		PN:	Packing unit:
		L	Ø		
51301 5	1/2"	66	30	10	20/240
51302 2	3/4"	74	37	10	10/ 120
51303 9	1"	84	45	10	6/ 90
51304 6	1 1/4"	102	59	8	6/ 60
51305 3	1 1/2"	114	68	8	4/ 48
51306 0	2"	135	81	8	4/ 16
51307 7	2 1/2"	155	103		4/ 16
51308 4	3"	171	111		4/ 8
51309 1	4"	181	146		2/ 8

Stainless steel pre-filter male

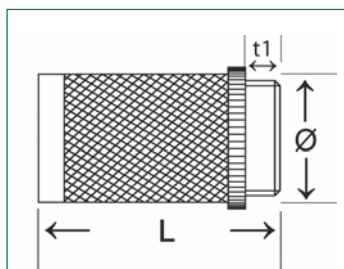
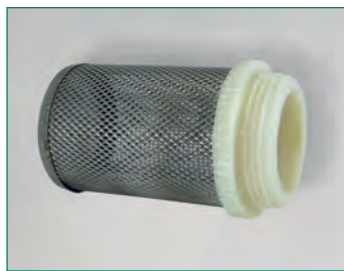

Fine-mesh stainless steel with plastic threaded connection, **without** eyelet

Item-No.:	Connection:	Thread length:	Length:		Packing unit:
		t1	L	Ø	
51311 4	1/2"	8	40	27,5	18/432
51312 1	3/4"	7	45	34	15/300
51313 8	1"	10	54	40	15/300
51314 5	1 1/4"	10	61	48	10/100
51315 2	1 1/2"	10	69	58	5/100
51316 9	2"	12	84	68	5/100
51317 6	2 1/2"	14	95	83	-/-
51319 0	4"	16	152,5	129	-/-

Stainless steel pre-filter female

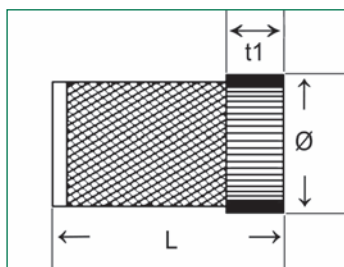
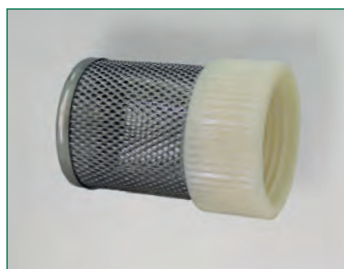

Fine-mesh stainless steel with plastic threaded connection, **without** eyelet

Item-No.:	Connection:	Thread length:	Length:		Packing unit:
		t1	L	Ø	
51313-IG	1"	13	57	31	15/300

Stainless steel pre-filter

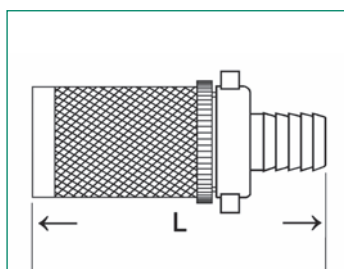

Fine-mesh stainless steel with plastic threaded connection and removable hose connection, **without** eyelet

Item-No.:	Connection:	Length:	Packing unit:
		L	
51331 2	1/2"	70	-/-
51332 9	3/4"	73	-/-
51333 6	1"	90	-/-
51334 3	1 1/4"	105	-/-
like 51333, but with non-detachable nut (without illu.)			
51333-10882	1"		-/-

Foot valve made of brass

Fine-mesh stainless steel with plastic threaded connection, **with** eyelet and snap hook (for 51363) and tube spout made of brass

Item-No.:	Conne.:	Thread length: t1	Length:		Packing unit:
			L	Ø spout	
S-3064-1"	1" x G1"		116,5	27 mm	-/100
S-3064-1 1/4"	1 1/4" x 1 1/4"		120,5	32 mm	-/ 60

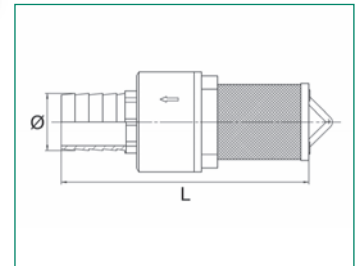
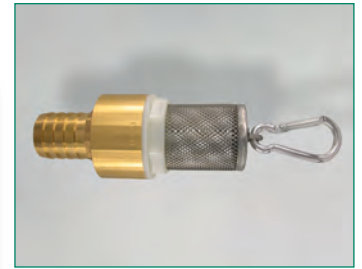

Stainless steel pre-filter

Fine-mesh stainless steel with plastic threaded connection, **with** eyelet and snap hook

Item-No.:	Conne.:	Thread length: t1	Length:		Packing unit:
			L	Ø	
S-91	M 1"	10	52,5	35 mm	10/180

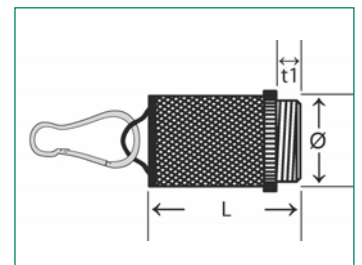

Stainless steel pre-filter

Fine-mesh stainless steel with eyelet and snap hook, male thread 1" stainless steel

Item-No.:	Conne.:	Thread length: t1	Length:		Packing unit:
			L	Ø	
S-1504	M 1"	14	132	100 mm	1/13

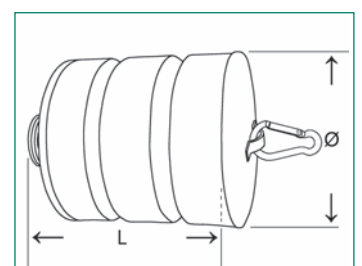
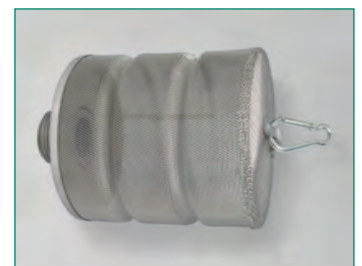

Floating suction filter

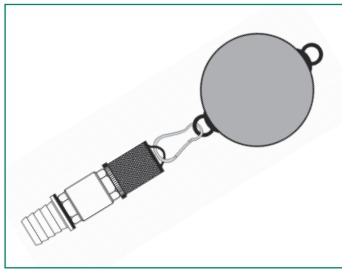
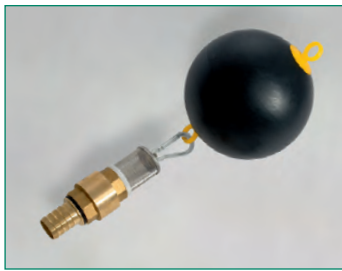

For rainwater cisterns or the like, black PE-ball (Ø 145 mm) with two eyelets, foot valve stainless steel strainer, hose tail 1"

Item-No.:	Connection:	Packing unit:
51363 3	1" x Ø 35 mm	1/10
51364 0	1" x Ø 100 mm	1/ 8
Individual components (depending on version)		
S-1668	Ø 145 mm	Float ball, black
S-91	M 1" x Ø 35 mm	Stainless steel pre-filter with eyelet
S-1504	M 1" x Ø 100 mm	Stainless steel pre-filter with eyelet
S-3064-1"	1" x G1"	Check valve with spring and hose tail
S-91-Haken-B		Stainless steel spring hook

Replacement spring hook

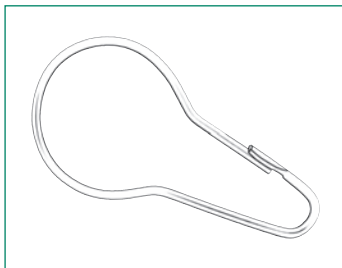

Spare parts for filters, stainless steel spring hook, pear shape

Item-No.:	Suitable for item:	Connection: B x L x Ø	Packing unit:
S-91-Haken-B	S-91 + S-1504 + 51363 + 51364	35 x 65 x 2,3 mm	-/400

Replacement snap hook



Spare parts for filters, snap hook aluminium/stainless steel, anodized

Item-No.:	Suitable for item:	Connection: B x L x Ø	Packing unit:
S-91-Karabiner	S-91 + S-1504 + 51363 + 51364	26 x 51 x 5 mm	500/2000

puteus GmbH terms and conditions for contracting, delivery, and payment

Section 1 General

1. These general conditions of sale apply to all present and future business relations with companies, legal persons governed by public law, and separate estates under public law with respect to deliveries and other services including work orders and the delivery of non-fungible items.
2. The buyer's purchasing terms will not be recognized even if puteus GmbH does not explicitly object to them upon becoming aware of them or after receipt unless puteus GmbH explicitly approves of their validity in writing.

Section 2 Offerings

1. Offerings from puteus GmbH are non-binding and subject to availability.
2. The right to make reasonable technical changes in the form, color, and/or weight of offerings is reserved.

Section 3 Shipping

1. Shipping, including free delivery, is at the buyer's own risk. Selection of the routing is hereby ceded to puteus GmbH. The buyer will bear the shipping costs unless an agreement to the contrary has been made in writing.
2. Transportation insurance will only be obtained upon written request by the buyer and at the buyer's expense. Any damages incurred in transit are to be immediately reported to the carrier and to puteus GmbH.
3. If items should be delivered in returnable containers, then the containers are to be emptied of residues upon receipt and promptly returned carriage paid. Loss or damage of re-use packaging will be at the buyer's expense if the buyer is responsible.
4. Non-returnable packaging will not be accepted by puteus GmbH and must be disposed of by the customer and the customer's expense.
5. Returnable containers that are not explicitly included in the price or the invoice amount will only be made available on loan. They will remain the property of puteus GmbH.

Section 4 Passage of risk

The risk of accidental loss or accidental impairment of products will pass to the buyer upon delivery or, in the event of sale by dispatch, with the handing over of the item to the shipper, carrier, or other person or institution designated to execute the act of shipping.

Section 5 Delivery/acceptance

1. Delivery periods are approximate. They are subject to timely receipt of supplies. If puteus GmbH does not adhere to agreed delivery periods, then the buyer is to set an appropriate subsequent delivery period of at least three weeks for puteus GmbH in writing starting upon receipt of the new deadline by puteus GmbH. The buyer will be entitled to withdraw upon expiration of the subsequent deadline. puteus GmbH will be authorized to make subsequent delivery until a written declaration of withdrawal has been received.
2. In the event of force majeure, industrial action, or other faultless stoppages that last longer than one week, the delivery or acceptance period will be extended by the duration of the hindrance up to a maximum of five weeks in addition to a subsequent-delivery period. The extension will only come into effect if the reason for the hindrance is promptly reported to the other party as soon as it has been observed that the aforementioned period cannot be complied with.
3. Partial deliveries are permissible.
4. In the event that the buyer should default in taking delivery, puteus GmbH will be authorized, after setting a five-day grace period, to invoice the buyer as of the time that the product was provided or to withdraw from the agreement or to demand compensation for damages at its own discretion. Storage of products that are not accepted by the buyer will be at the buyer's own risk and will take storage costs into account.

Section 6 Sample materials

1. Samples will be delivered at cost. In the absence of any agreement to the contrary, samples that have been loaned to the buyer by puteus GmbH will remain our property.
2. In consideration of technical or material-dependent deviations in production, samples are not considered samples in the meaning of Section 454 of the German Civil Code (BGB).

Section 7 Prices

1. puteus GmbH prices are net prices and do not include statutory value-added tax.
2. If there should be a period of more than four months between the conclusion of the agreement and delivery, then the puteus GmbH prices as of the day of delivery will apply. This will not apply if delivery has been delayed due to the fault of puteus GmbH.

Section 8 Payment

1. puteus GmbH invoices will be issued on the day of delivery or provision of the product. Payment will be due in full within 30 days of the invoice date. In the event of payment within eight days of the invoice date, puteus GmbH will grant a cash discount of 2% of the remaining invoice amount after any trade discounts have been deducted.
2. Upon payment after the due date, puteus GmbH will calculate an interest rate of an additional 8% above the base rate. Both puteus GmbH and the buyer will be at liberty to present evidence of greater or lesser damage.
3. The credit balance may only be adjusted based on claims that are uncontested or that have been determined without further legal recourse. The same applies to withholding due invoice amounts unless the counterclaim is based on the same statutory relationship.

4. puteus GmbH will not be obligated to make further deliveries on the basis of any current contracts until due invoice amounts have been paid in full, including interest. If after a contract has been concluded it should become apparent that puteus GmbH's pecuniary claim is in jeopardy due to the buyer's insolvency or if the buyer should be in default on a significant payment amount or if other circumstances should arise indicating that the buyer's solvency has significantly deteriorated, then the rights according to Section 321 of the German Civil Code (BGB) will accrue to puteus GmbH. puteus GmbH will then also be authorized to accelerate all claims that are not yet due based on the current business relationship with the buyer

5. The supplier is entitled to assign his receivables against buyers to a third party.
6. The buyer is obliged to reimburse any fees, costs and expenses in connection with any successful legal prosecution against him outside Germany.

Section 9 Liability for defects

1. Obvious defects or other objections with respect to the delivery item – including the absence of guaranteed or warranted qualities – are to be promptly reported to puteus GmbH in writing no later than 14 days after receipt of the delivery item.
2. puteus GmbH assumes no liability for deviations in quality, color, size, (specific) weight, or equipment that might arise in the course of normal business practice, are minimal, or are unavoidable. Application-specific verbal and written consultation from puteus GmbH – including from puteus GmbH's vendors – will not exempt the buyer from responsibility to examine delivered products for their intended purpose.
3. No objections to obvious defects will be accepted after the product has begun to be processed.
4. Upon receipt of valid notice of defect within the prescribed time limit, puteus GmbH may choose to eliminate the defect or deliver a non-defective product (supplementary performance) at its own discretion. In the event that puteus GmbH should fail or refuse to execute supplementary performance, the buyer may withdraw from the agreement or reduce the purchase price after an appropriate period has unsuccessfully elapsed. If the defect is insignificant or if the product has already been sold, processed, or altered, then the buyer will only be entitled to a reduction of payment.

Section 10 General limitation of liability, statute of limitations, and right of recourse

1. puteus GmbH, including its management and other auxiliary persons, will be liable for violations of contractual or non-contractual obligations, particularly due to impossibility, delay, fault in preparing the contract, or tort, only in the event of wrongful intent or gross negligence and only with respect to damages that are typical of the contract and that are foreseeable at the time that the contract is concluded. For the remainder, liability on the part of puteus GmbH is also excluded for damages caused by defects and consequential damages.
2. These restrictions will not apply to culpable violation of essential contractual obligations that jeopardize the purpose of the contract; in the event of culpably induced harm to life, body, or health; if and to the extent that puteus GmbH has guaranteed the state of the purchased item or has assumed a procurement risk; nor in cases of compulsory liability according to the German Product Liability Law. This will have no effect on regulations concerning the burden of proof.
3. In the absence of any agreement to the contrary, the statutory limit on contractual claims against puteus GmbH that accrue to the buyer by reason of and in connection with product delivery will be one year after delivery of the product. This term will not apply to products that are used for a construction in a manner that is in keeping with their conventional use. This will have no effect on puteus GmbH's liability arising from intentional or grossly negligent breaches of obligation or culpably induced harm to life, body, or health.
4. The buyer's right of recovery in accordance with Section 478 of the German Civil Code (BGB) against puteus GmbH is restricted to the statutory scope of warranty claims that are invoked against the buyer by a third party and assumes that the buyer has fulfilled its obligation to puteus GmbH to give notice of defects in accordance with Section 377 of the BGB.

Section 11 Reservation of ownership

1. Delivered products will remain the property of puteus GmbH until all claims as of the moment that the contract was concluded have been paid in full regardless of the legal basis for the claims. This will apply even if payments for particularly specified claims have been made. Neither the suspension of individual claims in a current account nor the balancing of accounts and acknowledgment thereof will affect the reservation of ownership.
2. If the reserved product that was delivered to the buyer should be machined or processed by the buyer, the machining or processing by the buyer will be executed by the buyer for puteus GmbH without any obligations accruing to puteus GmbH. If the delivery item is connected to, mixed with, or combined with items that do not belong to puteus GmbH, then puteus GmbH will be come the co-owner of the total item in accordance with statutory provisions. If the buyer should acquire sole ownership of the new item, then it hereby transfers co-ownership of the items connected to it to puteus GmbH in proportion to the value of the delivery item at the time that the connection was made.
3. If the buyer should sell the reserved product individually or in conjunction with a product that does not belong to puteus GmbH, then the buyer hereby assigns the claims resulting from the resale to puteus GmbH in the amount of the value of the reserved product with all ancillary rights and claims that accrue in lieu of the reserved product. If the resold product is co-owned by

puteus GmbH, then the claim assignment will extend to the amount that corresponds to puteus GmbH's share of the co-ownership. puteus GmbH hereby accepts these assignments. Incorporation of the reserved product into built structures will also be considered a sale.

4. The buyer is hereby authorized to collect on claims arising from resale. This collection authorization will become void if it should be revoked by puteus GmbH no later than the moment of a default on payment, non-payment of a bill, or petitioning for the initiation of bankruptcy proceedings. puteus GmbH will only invoke its right to revocation if, after the conclusion of the agreement, it becomes apparent that puteus GmbH's pecuniary claim arising from this or from another agreement with the buyer is in jeopardy due to the buyer's insolvency. Upon request by puteus GmbH, the buyer will be obligated to immediately inform its own buyer of the assignment to puteus GmbH and to promptly transfer to puteus GmbH the documents necessary for collection, in particular the buyer must transfer to puteus GmbH a precise summary of its claims with the name and mailing address of its own buyer and must provide puteus GmbH with all the information necessary to assert the assigned claims. The buyer hereby authorizes puteus GmbH to inform the secondary buyer of the assignment and to collect on the claims immediately upon default on a payment or deterioration of its financial circumstances. puteus GmbH will have the right to demand that the legal validity of the assigned claims be examined by a representative based on the buyer's accounting. The buyer must provide puteus GmbH with a summary of the reserved products that are still on hand.
5. If the buyer should act in breach of contract, and particularly in the event of a default on payment, puteus GmbH will be authorized to withdraw the delivery item after giving formal notice and setting a time limit and the buyer will be obligated to return it. Neither assertion of the reservation of ownership nor seizure of the delivery item by puteus GmbH will be considered withdrawal from the agreement.
6. The buyer is hereby authorized and empowered to resell, use, or incorporate the reserved product only in the conventional and proper course of business and only on the understanding that claims that have been assigned in accordance with the provisions above will in fact proceed to puteus GmbH. The buyer is not authorized to otherwise transfer the reserved product. The buyer may not pledge the reserved product nor transfer ownership as collateral. The buyer's authorization in accordance with the first sentence of this paragraph will not apply in the event of impending or already established insolvency or in the event of other essential deterioration of its financial circumstances.
7. The buyer must both promptly inform puteus GmbH of enforcement measures undertaken by third parties with respect to the delivery item with reserved ownership or the claims assigned to us and deliver the documents necessary to challenge the enforcement.
8. If the value of the total collateral granted to puteus GmbH should exceed puteus GmbH's claims by more than 20%, then puteus GmbH will be obligated and prepared to return or release to the buyer the collateral granted to puteus GmbH to the extent that it exceeds the agreed coverage limit.

Section 12 Blanket orders and call orders

1. If an on-call purchase is agreed with the buyer, then payment for outstanding deliveries will be due automatically upon expiry of the on-call term. The buyer will then be obligated to call for the outstanding deliveries and to pay the agreed purchase price as paid for the transfer of the property. With respect to any individual installment, in addition to fulfillment, puteus GmbH will have the right to demand compensation for pecuniary detriment or to proceed in accordance with Section 323 of the German Civil Code (BGB).

2. If the buyer should fail to call for the agreed deliveries within the agreed on-call term, then puteus GmbH will have the right to otherwise utilize the products without fixing a time limit. The same will apply if the buyer should file for bankruptcy within the on-call term and/or become insolvent.

Section 13 Price clause

puteus GmbH hereby reserves the right to reasonably change its prices for all orders – including on-call orders and call-off contracts – that, either contractually or at the buyer's request, are delivered more than three months after the order was placed if costs should decline or increase after the contract was concluded, particularly due to wage increases or changes in the cost of materials. The orderer will be provided with evidence of such changes upon request.

Section 14 Proprietary rights, tools, models, and illustrations

1. If items are delivered based on illustrations or other details provided by the buyer, then it will be the buyer's responsibility to ensure their accuracy and that no third party proprietary rights are violated. The buyer must indemnify puteus GmbH against any claims by a holder of proprietary rights.
2. puteus GmbH may invoice for molds, models, tools, and equipment that are required for the ordered product. They will remain property of puteus GmbH even if puteus GmbH manufactured them on behalf of the buyer and/or has paid the buyer in whole or in part. This will apply even if they were manufactured according to special instructions from the buyer, which uses them exclusively for deliveries to the orderer, as long as it fulfills its commitment and payment obligations and the business relationship persists.
3. If no parts are reordered two years after the last production, then puteus GmbH, after giving appropriate notice to the buyer and after a period of six weeks from receipt of notice by the buyer, will have the right to scrap or otherwise utilize the molds, models, tools, and manufactured equipment.
4. If the buyer should file for bankruptcy, puteus GmbH will be authorized to scrap or otherwise utilize the molds, models, tools, or manufactured equipment before two years have expired and without notifying the buyer in advance.

Section 15 Return of catalog products

Catalog products may only be returned due to product redelivery according to prior agreement and are to be undertaken freely. 30% of the handling costs will be deducted from any credit entries for re-saleable products.

Section 16 Place of fulfillment/legal venue

1. The place of fulfillment for all claims arising from the contractual relationship will be puteus GmbH's principle place of business.
2. For all present and future claims arising from the business relationship, including bills and checks receivable, the legal venue will be puteus GmbH's corporate headquarters. This will apply even if the buyer has no legal venue in Germany or if the buyer's domicile or usual residence is unknown at the time when proceedings are instituted. puteus GmbH will also be authorized to bring an action at the buyer's principle place of business.
3. The laws of the Federal Republic of Germany will apply. The terms of the United Nations Convention on Contracts for the International Sale of Goods will not apply.
4. If particular terms of the agreement with the client, including these General Terms and Conditions, should be or become legally inoperable in whole or in part, the validity of the remaining terms will be wholly or partially unaffected. The wholly or partially inoperable provision will be replaced by a provision whose commercial outcome approximates that of the inoperable term as closely as possible.

puteus GmbH, Lenenweg 6, D-47918 Tönisvorst
Version: November 2023

TECHNICAL INFORMATION

Size and weight

Unless otherwise stated, all dimensions are in millimeters (mm) and weights are in grams (g).

PN = nominal pressure in bars 1 bar 10N / cm² ⇒ ca. 10 m column of water

DN = nominal diameter in inches or mm 1" = 25,4 mm ⇒ ca. 25 mm

Nominal pressure is the maximum applicable pressure at the standard temperature, which, unless otherwise stated, is 20°C.

Nominal diameter is the excess pressure when all operational conditions are taken into consideration, including pressure surges. It depends on the operating temperature, the medium, the size of the component/valve, and, where applicable, the type of seal.

There are legal provisions or regulations that apply to certain areas of application and that take precedence over the guidelines provided in this catalog.

Medium

The details presented in this catalog with respect to pressure and temperature conditions refer to water.

Suitability for gases, oils, or glycolic or other media should be investigated in light of the operating pressure and operating temperature. Our applicability information may not be applied to media or operating conditions other than those that have been approved without our clearance.

Custom models

If there are no articles in our standard program that are suitable for your needs, we can also create custom models upon request. For this, we would need a detailed letter of inquiry with the corresponding number of units as well as drawings or sample parts.

Installation instructions

A) Screw thread

Connection dimensions and screw thread of complementary proportions must always be selected.

The screw thread should not be too strongly sealed with hemp or sealing tape, which is to say that after the hemp has been applied, the crest of the thread must still be visible. Sealing the thread too strongly will increase the pressure in the component. Over time, that pressure can cause cracks.

To avoid causing damage during installation, the components should be conventionally screwed in with the appropriate, customary tools, without excessive force and without lever extension.

Self-sealing valves must not be sealed further with hemp or sealing tape. The corresponding mating thread must be of sufficient length (min. 12 mm). Where applicable, components are only to be installed on the spanner flats provided for that purpose by means of a suitable spanner/pliers. Our products must be installed without tension in due consideration for the information above. Alignment, e.g., of connections that we provide by means of heating appliances, is prohibited because this can also cause tension cracks and secondary damage later on.

Where applicable, connecting different metals or alloys can cause corrosion, for which puteus GmbH cannot be held liable (e.g., connections between brass and stainless steel or copper with zinc-plated metals). These characteristics are to be checked before our products are installed.

The components' pressure and sealing are to be carefully tested after installation. Where applicable, the installation instructions that are enclosed with the components are to be observed when doing so.

B) Gate valve

After disassembly/repairs/maintenance work, the upper section is only to be reassembled with a raised sealing wedge. Do not damage sealing surfaces/key seats. Sealing wedges cannot be replaced.

C) Socket slide valve

These must only be installed in closed position. Key seats must not be damaged by screwing in pipes by force.

D) Ball valves

To ensure operability, for example, only set ball valves on very low static and dynamic power. Where applicable, the component should be supported by appropriate measures (e.g., pipe clamps or similar). The torque to be applied to the ball valve must only be applied to the spanner flats at the end that is being screwed in, otherwise there is a risk that the ball valve could be unsealed or cracked. Likewise, bodies and ball valve screwing components must not be screwed against one another. Doing so would also cause leaks and/or the risk of breakage.

E) Pipe and hose connections

According to DIN EN 1717 pipe and hose connections for devices that contain non-potable water (e.g. washing machines) must be connected to a water intake using a backflow preventer to avoid any backflow of polluted water into the potable water line.

Recommendations for the use of ball valves

1. General information

Ball valves serve as shut-off valves for pressurized media. The manufacturer's information on flow media, operating pressure and temperature range must be respected. Using other than approved media may shorten the ball valve's lifespan or lead to a failure of the ball valve.

The installation may only be carried out in systems with equal pressures. Any possible pressure surges due to the quick-lock system must be taken into account as these may damage the piping system. The valve can be opened and closed by a 90° turn of the lever, intermediate positions of the lever are not allowed during the operating condition.

Ball valves should be stored in a dry place, free of dirt and without direct sunlight.

2. Installation and removal instructions

Ball valves may only be used in compliance with the requirements for their intended use. The installation must be carried out stress-free and with appropriate tools in a pressure less state only by qualified and trained staff. Do not turn the ball valve forcibly and do not use it to align the pipeline. The ball valve must be checked for damage before installation. Plumbing lines must be rinsed before first commissioning after maintenance and repairs.

Do not clamp the ball valve too tightly in a vise or something similar for pre-assembly in order to avoid damage and stress cracks on the body. According to the general installation instructions you must not seal the threads with too much hemp. The tips of the threads must remain visible. When installing the ball valve only use the designated spanner flat at the installation side to apply the counter-torque. Never apply the wrench to the body or to the side opposite of the installation side. Do not exceed the recommended tightening torque, any existing sensor plugs must be tightened to 15 Nm. The handle must not be used as a mounting lever.

The use of quarter-turn ball taps is only allowed with free outflow to avoid a backflow of sewage into the pipeline. Quarter-turn ball taps are not suitable for the use in domestic water-pipe systems or as device connection taps. It is necessary to carry out functional and leak tests after installing and before the ball valve is put into operation for the first time.

3. Commissioning

Operating conditions and installation works must be checked again before commissioning. Notice: Due to a long-term storage or long downtimes the release torque may be much higher than the usual turning moment.

Before initial start-up or putting into operation after maintenance work the pipeline has to be deaerated. In case of pressure surges air bubbles may cause explosions or damages to the piping system. Therefore the pressure should only be slowly increased.

Ball valves at the end of a pipeline must be sealed professionally with a blind flange to avoid the valve being forcibly torn off. Caution! Danger!

The ball valve may not be operated with a tool that shall serve to increase the leverage (e.g. hammer, pliers, extension tubes etc.)

4. Maintenance and inspection

Depending on the assembly situation, ball valves have to be drained before the first frost sets in as well as before cleaning works. When emptying the valve the handle should be in a 45-degree-position to make sure that the dead space may be emptied, too. Tests for tightness, functionality and damages should be carried out regularly. Depending on the operating situation this should be done in shorter time intervals. During long periods of disuse the ball valve should be put into operation every few months to guarantee proper functioning.

Defective or corroded valves or valves that do not work properly must be replaced during maintenance work. Replacement and removal may only be carried out by qualified personnel whilst the pipeline is not under pressure.

5. Warnings

The manufacturer will not accept any liability for deficiencies caused by assembly errors, improper handling, the use of impermissible media or not allowed operating situations as well as for damages due to normal wear and tear.

Ball valves may not be used as throttle valves! They may only be used in a fully opened or closed situation to avoid damages to seals in the spherical area. Depending on the operating situation the ball valve's body can get very warm. Caution!

Legal health and safety regulations, national rules and technical rules and standards for certain operating and mounting situations have to be observed. Viscous fluids or hardenable media as well as certain chemical substances may impede the function or make it impossible. Please refer to the manufacturer's information.

Polluted or sandy media may cause damages to the seals. In case of neglecting the given information on working pressure or working temperature leaks may occur or the ball valve may tear apart. Caution!

(as of November 2023)

Further Information:

Unless otherwise indicated or unless they are provided with drain plugs that are used to empty the valve before the frost season, no valves (taps, check valves, foot valves, gate valves, ball valves, etc.) are frost-resistant.

Our ball valves, valves and fittings have to be installed without mechanical tension. They must not be used for adjusting pipings.

Chrome plated surfaces, e.g., on bathroom fixtures or device connector valves, are sensitive to lime-dissolving agents, acidic cleaners, and all types of

abrasives. These surfaces must only be cleaned with clear water and a soft cloth (leather).

Our pumps, wall and standing fountains are provided with a protective coating for transport purposes by the manufacturer. This first layer of paint is not considered to be a permanent corrosion protection or optical coating.

We offer no guarantee for wearing parts in the event of corrosion or malfunction due to very hard water or contaminated water lines (e.g., with respect to sealing or mixing jets) or due to improper assembly; chemical or mechanical events during transportation, storage, connection, repair, or use; or improper handling of products.

We provide the statutory guarantee for defects in our products that arise due to material or manufacturing defects or through normal use. Defects due to non-observance of the information above are excluded from that guarantee.

Previous documents cease to be valid upon publication of the catalog. Our catalog serves exclusively as a basis for wholesale, industrial, and technical information and work. It is not a sales document.

Returns are only permitted based on prior written agreement; this particularly applies to custom production. Return deliveries that are not prepaid will not be accepted.

Recommendations for the handling of hoses

A number of factors can have an impact on how long the hose lasts:

- application
- medium
- abrasion
- storage etc.

Therefore it is not possible to give a general information about the durability of a hose. The end user should regularly check the hose for leaks and replace it if necessary.

The rubber compound can change its characteristics over time because of its chemical properties. This process can be accelerated by improper use of the hose or other influences. Therefore we give the following recommendations:

Storage

1. Avoid long storage periods! Otherwise, a check is important at the 1st use.
2. Ideally you should store the hose at a temperature between +10°C and +25°C. Temperatures of less than 0°C or more than +40°C will damage the hose. Keep the hose away from all sources of heat! Avoid dry air as well as high air humidity!
3. No direct solar radiation or aggressive artificial light!
4. Airflow and ozone can ruin the material. Do not store near electric motors, high-voltage units etc. because of the danger of sparks or electrostatic charge or uncontrolled heating of eventually mounted metal couplings.
5. Different substances can affect the material of the hose. Therefore please avoid any contacts with: solvents, fuels, acids, disinfectants, wood preservers, volatile or organic chemical substances or mixtures. Manganese, iron, copper and copper alloys may affect some kinds of rubber mixtures.
6. Store loosely rolled and stress-free to avoid compressing the tube. Coiled hose should be stored in a horizontal position. Do not pile up and pay attention to the weight to avoid any deformations! If given by the supplier, please note the minimum bend radii to prevent kinks.
7. Check the hose for suitability and proper seat of mounted couplings before delivery or resale.
8. Clean the hose before re-storage (please check suitability of the cleaning agent !). This applies particularly in case of the use of chemical, explosive or abrasive materials. Checks for reusability are essential.

Use

1. Hoses should only be used in accordance to their intended purpose. The misuse –e.g. as towing rope- is not allowed.
2. Before using the hose you have to check its suitability with regard to its characteristics, type or size.
3. Exercise due diligence when transporting the hose. The hose may not be exposed to severe shocks or tensile forces across rough surfaces. Avoid twisting, kinks and knots.
4. Please note the mentioned operating pressures! If checking the hose for leaks, the pressure in a hose free of air bubbles must only be increased gradually until the maximum pressure is reached.
5. The hose has been developed to channel liquids which are approved by the manufacturer. This does not give the permission to immerse the hose in the liquids.
6. Please note the ambient temperature and the maximum operating temperature which depend on the medium. Keep hose line away from sources of heat!
7. The material of the hose must be resistant to all media used. Check this before use. Changes in the concentration of media, period of use or temperature may cause changes in the suitability and chemical resistance of the hose.
8. Varying degrees of abrasion may occur depending on the kind of medium used or pulling the hose across different surfaces. Therefore you have to control the wear and tear of the tube regularly.
9. Make sure that installed hoses and hose connections are protected against impurities to avoid a contamination of hose and medium; particularly when used with drinking water.
10. Do not install hose lines on driveways or rather protect them against running over. If necessary, use hose bridges or the like.
11. Mounted hose fittings or spray nozzles should not be used as end or shut-off valves as they are not constructed for that purpose. Do not expose them to a permanent water pressure to prevent the valve/nozzles from being torn off and/or avoid bursting of the hose. After finishing work the water supply to the hose has to be shut off.

Assembly and commissioning of hose lines in technical fields

Please note:

1. When using hoses fitted with connectors, ensure that they are the correct length. An extension through the use of several connecting hoses is not permissible.
2. Before putting a hose line into operation please check if it is in accordance with eligible regulations and directives, e.g. the instructions of the Trade Association To02, §§14 and 15; the Industrial Safety Regulation (BetrSichV) or the Technical Rules for operating safety (TRBS).
3. Do not use a hose line if there are any visible damages!
4. Hose lines with given inspection intervals may not be used when the inspection date has expired. After repair or modification the hose line must be checked.
5. The hose line must be cleaned before putting it into operation. Do not forget to check the suitability of the cleaning agent!
6. With regard to electrostatic discharge the following instructions have to be observed: TRBS 2153 ("Avoiding of ignition hazards due to electrostatic charges")
7. The hose line must be cleaned when changing from one to another flow medium to avoid a possible chemical reaction or contamination of the new medium.
8. For special applications or construction projects, it is essential to comply with the manufacturer's instructions.

Disposal

Please follow local regulations if you want to dispose hose materials and/or hose fittings.

Legal information: According to the Drinking Water Ordinance [esp. §§ 3 and 17], every tapping point of water that is not intended for human use must be permanently marked with a notice "no drinking water" and safeguarded against inappropriate use!

Tapping systems for non-drinking water that are installed in the household in addition to the drinking water supply system must be reported to the health authority!

Specifications and illustrations as well as descriptions and packing units are non-binding. They are purely informational and no legal obligation may be derived from them.

We reserve the right to make technical and formal changes in the interest of further technical development or that are necessary for financial reasons. Alterations and additions are made continuously.

We assume no liability for any printing errors or divergent illustrations. In the event of erroneous size information, the figures at the start of printing will no longer apply.

Conversion table inch/millimetre

inch fractional value	mm metric	inch fractional value	mm metric
1/8"	3,175 mm	1 3/4"	44,450 mm
1/4"	6,350 mm	2"	50,800 mm
3/8"	9,525 mm	2 1/4"	57,150 mm
1/2"	12,700 mm	2 1/2"	63,500 mm
5/8"	15,875 mm	2 3/4"	69,850 mm
3/4"	19,050 mm	3"	76,200 mm
7/8"	22,225 mm	3 1/4"	82,550 mm
1"	25,400 mm	3 1/2"	88,900 mm
1 1/4"	31,750 mm	3 3/4"	95,250 mm
1 1/2"	38,100 mm	4"	101,600 mm



We keep an eye on our qualities:

Both our quality and environmental management system have been certified on the standard basis DIN EN 9001 (Nov. 2015) and DIN EN 14001 (Nov. 2015). We face the challenge to guarantee highest qualities for our products and services. All raw materials and external products are checked for quality and suitability. Our own products are tested on a random basis during the production processes, final leaking and material tests are performed.

Our products meet several requirements, such as DVGW, SVGW, KTW, noise class tests (PA-Nr.), ACS and are also complying with binding DIN standards in respect to dimensions or noise behaviour.

With regard to the brass alloy **puteus** valves, fittings and the seals we use are in full compliance with the amended requirements of the drinking water ordinance. Long before the reference date in April 2017 we made sure that the regulations of the valuation basis of the Federal Environmental Agency (UBA) were implemented. These regulations apply to metallic materials which may get in contact with drinking water. They also include the list of materials that are in accordance with the drinking water hygiene (known as the "UBA Positive List"). On the basis of these standards our quality management has also been certified for the process to comply with the nickel values for valves, fittings and other components in drinking water under the terms of the drinking water regulations and recommendations of the Federal Environmental Agency.

Therefore we can ensure a high product quality for our customers because of our high quality awareness.

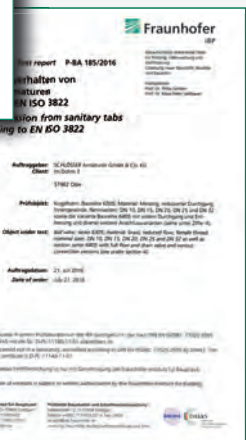

Disclaimer:

puteus GmbH | Lenenweg 6 | 47918 Tönisvorst
 Domizil Tönisvorst | AG Krefeld | HRB 9505 | UST-IDNR. DE 120 581 001 | ILN 40 12167 00000 3
 CEO: Hans de Gruyter | Peter de Gruyter

© 2023

Our packaging and labelling proposals

Four-colour cartons – version 1 –

with Euro-standard-holes, colour prints and product descriptions on the front-side, pictographs and installation dimensions on the back, top and bottom. Items that are available in carton packaging can be found in our catalogue. The item numbers are marked with an additional “-K”.



Four-colour cartons – version 2 –

Promotional four-colour cartons with product photos and descriptions.



Labels with EAN-barcodes

Nearly all articles can be labelled with EAN-codes. The self-adhesive and tear-resistant labels contain a product description, barcode and EAN-code.

The complete EAN-code consists of:

4012167 + item-no. + verification digit
(without “-E” or other extensions).



Self-service cards

These cards can be used for certain products of the irrigation sector. The cards are printed with article descriptions, sizes and EAN-codes.



Polybags

We offer customized polybags for single products. Each polybag can be printed according to your wishes.



Note: All information is subject to possible printing errors or changes in design or construction. Reprinting and photomechanical reproduction- also including excerpts - only with the authorization of puteus GmbH, Lenenweg 6, D-47918 Tönisvorst.



Other catalogs to our range:



1 Appliance connection fittings



2 Sanitary fittings, kitchen + bathroom



3 Garden hose fittings + valves



4 Fittings



5 Ball valves + heating valves



6 Hand pumps, hose + accessories



Eine starke Gruppe

puteus GmbH

Lenenweg 6 · D-47918 Tönisvorst

Tel.: +49 2151 9952-0

Fax: +49 2151 9952-99

E-mail: info@puteus.de · www.puteus.de